

## High efficiency ultrafast diode

### Features

- Suited for SMPS
- Low losses
- Low forward and reverse recovery times
- Low leakage current
- High junction temperature
- Insulated package: TO-220FPAB

### Description

Dual center tap rectifier suited for switch mode power supplies and high frequency DC to DC converters.

Packaged in TO-220AB, D<sup>2</sup>PAK, TO-220FPAB and I<sup>2</sup>PAK, this device is intended for use in low voltage, high frequency inverters, free wheeling and polarity protection applications.

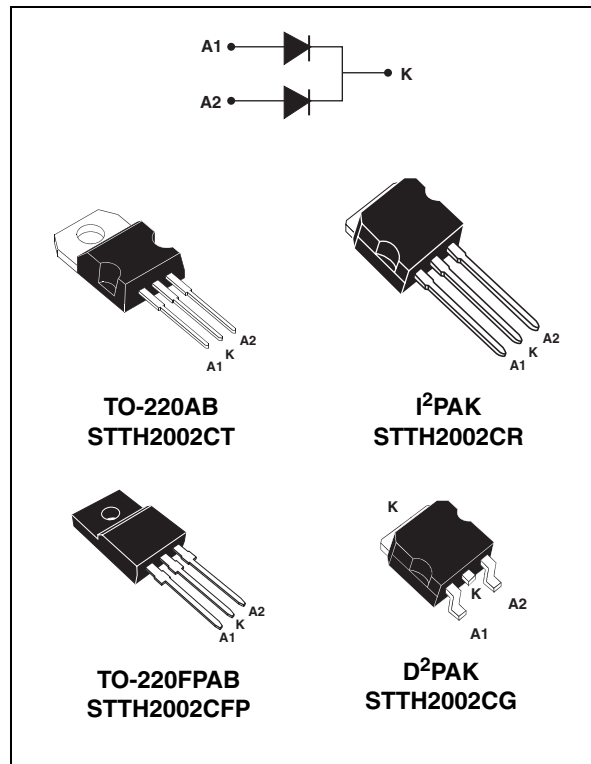

**Table 1. Device summary**

Symbol	Value
$I_{F(AV)}$	Up to 2 x 10 A
$V_{RRM}$	200 V
$T_j$ (max)	175 °C
$V_F$ (typ)	0.78 V
$t_{rr}$ (typ)	22 ns

# 1 Characteristics

**Table 2. Absolute ratings (limiting values, per diode)**

Symbol	Parameter		Value	Unit		
V <sub>RRM</sub>	Repetitive peak reverse voltage		200	V		
I <sub>F(RMS)</sub>	Forward rms current		30	A		
I <sub>F(peak)</sub>	Average forward current $\delta = 0.5$	I <sup>2</sup> PAK, D <sup>2</sup> PAK, TO-220AB	T <sub>c</sub> = 150 °C	Per diode	10	A
			T <sub>c</sub> = 140 °C	Per device	20	A
			T <sub>c</sub> = 130 °C	Per diode	15	A
			T <sub>c</sub> = 115 °C	Per device	30	A
		TO-220FPAB	T <sub>c</sub> = 120 °C	Per diode	10	A
			T <sub>c</sub> = 85 °C	Per device	20	A
I <sub>FSM</sub>	Surge non repetitive forward current		t <sub>p</sub> = 10 ms sinusoidal	90	A	
T <sub>stg</sub>	Storage temperature range		-65 to + 175	°C		
T <sub>j</sub>	Maximum operating junction temperature		175	°C		

**Table 3. Thermal parameters**

Symbol	Parameter		Value (max)	Unit	
R <sub>th(j-c)</sub>	Junction to case	I <sup>2</sup> PAK, D <sup>2</sup> PAK, TO-220AB	Per diode	2.5	°C/W
			Per device	1.6	
		TO-220FPAB	Per diode	5	
			Per device	3.8	
R <sub>th(c)</sub>	Coupling	I <sup>2</sup> PAK, D <sup>2</sup> PAK, TO-220AB		0.7	
		TO-220FPAB		2.5	

When the diodes 1 and 2 are used simultaneously:

$$\Delta T_j (\text{diode1}) = P_{(\text{diode1})} \times R_{\text{th(j-c)}} (\text{per diode}) + P_{(\text{diode2})} \times R_{\text{th(c)}}$$

**Table 4. Static electrical characteristics (per diode)**

Symbol	Parameter	Test conditions		Min.	Typ.	Max.	Unit
$I_R^{(1)}$	Reverse leakage current	$T_j = 25\text{ °C}$	$V_R = V_{RRM}$			10	$\mu\text{A}$
		$T_j = 125\text{ °C}$			6	100	
$V_F^{(2)}$	Forward voltage drop	$T_j = 25\text{ °C}$	$I_F = 10\text{ A}$			1.1	V
		$T_j = 25\text{ °C}$	$I_F = 20\text{ A}$			1.25	
		$T_j = 150\text{ °C}$	$I_F = 10\text{ A}$		0.78	0.89	
		$T_j = 150\text{ °C}$	$I_F = 20\text{ A}$			1.05	

1. Pulse test:  $t_p = 5\text{ ms}$ ,  $\delta < 2\%$

2. Pulse test:  $t_p = 380\text{ }\mu\text{s}$ ,  $\delta < 2\%$

To evaluate the conduction losses use the following equation:

$$P = 0.73 \times I_{F(AV)} + 0.020 I_{F(RMS)}^2$$

**Table 5. Dynamic electrical characteristics**

Symbol	Parameter	Test conditions		Min.	Typ.	Max.	Unit
$t_{rr}$	Reverse recovery time	$T_j = 25\text{ °C}$	$I_F = 1\text{ A}$ , $V_R = 30\text{ V}$ $di_F/dt = 100\text{ A}/\mu\text{s}$		22	27	ns
$t_{fr}$	Forward recovery time	$T_j = 25\text{ °C}$	$I_F = 10\text{ A}$ , $di_F/dt = 100\text{ A}/\mu\text{s}$ $V_{FR} = 1.1 \times V_{Fmax}$			200	ns
$V_{FP}$	Forward recovery voltage	$T_j = 25\text{ °C}$	$I_F = 10\text{ A}$ , $di_F/dt = 100\text{ A}/\mu\text{s}$		2.4		V
$I_{RM}$	Reverse recovery current	$T_j = 125\text{ °C}$	$I_F = 10\text{ A}$ , $V_R = 160\text{ V}$ $di_F/dt = 200\text{ A}/\mu\text{s}$		7.0	9.0	A

**Figure 1. Peak current versus duty cycle (per diode)**

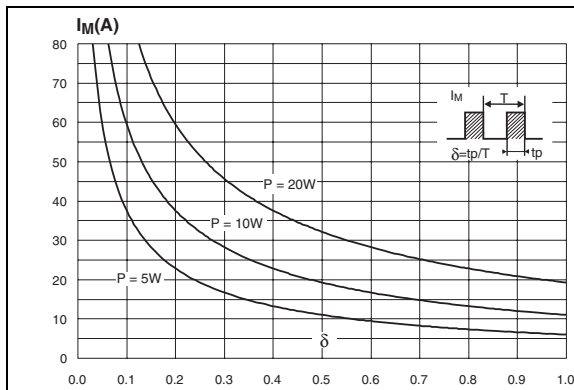

**Figure 2. Forward voltage drop versus forward current (typical values, per diode)**

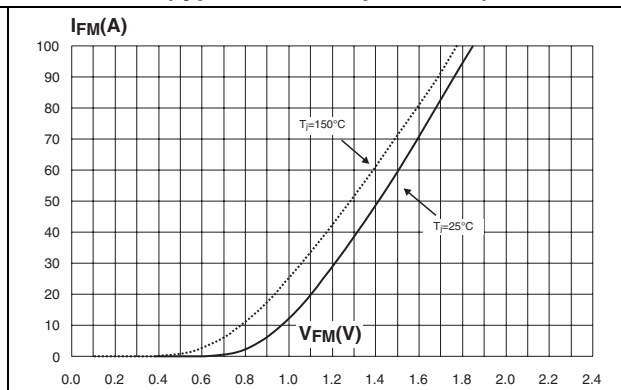

**Figure 3. Forward voltage drop versus forward current (maximum values, per diode)**

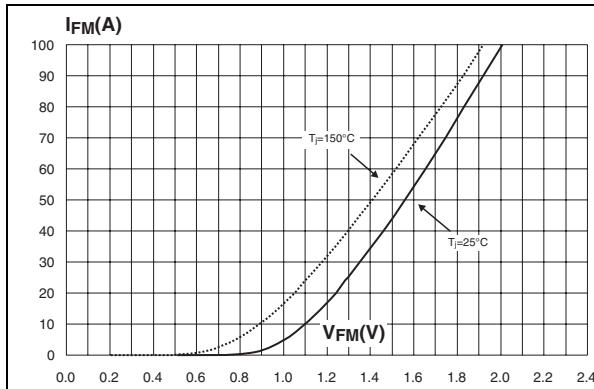

**Figure 4. Relative variation of thermal impedance junction to case versus pulse duration**

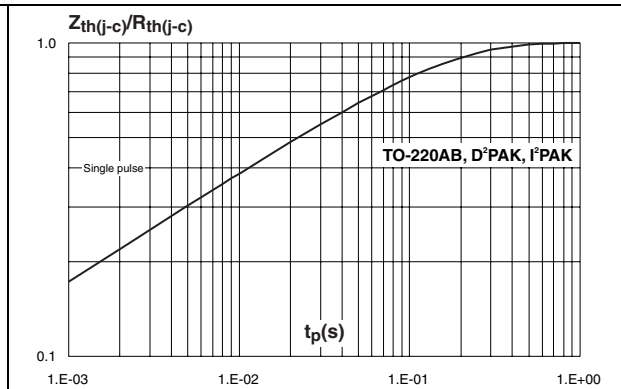

**Figure 5. Relative variation of thermal impedance junction to case versus pulse duration (TO-220FPAB)**

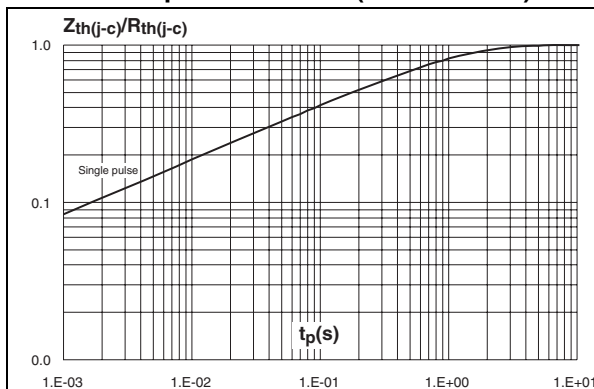

**Figure 6. Junction capacitance versus reverse voltage applied (typical values, per diode)**

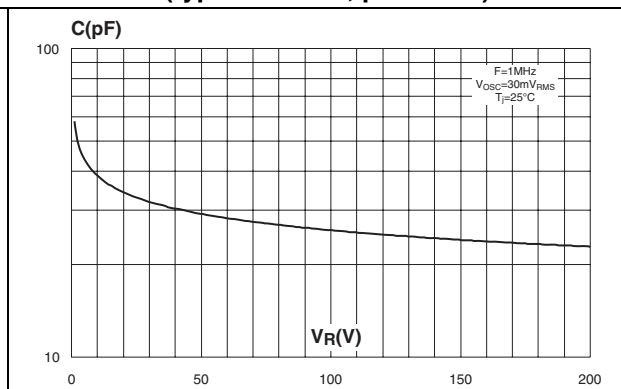

**Figure 7. Reverse recovery charges versus  $di_F/dt$  (typical values, per diode)**

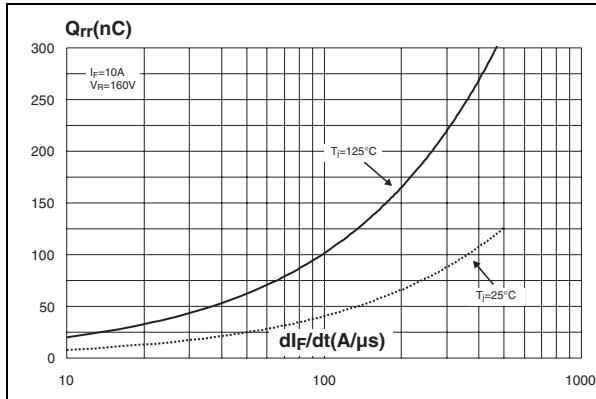

**Figure 8. Reverse recovery time versus  $di_F/dt$  (typical values, per diode)**

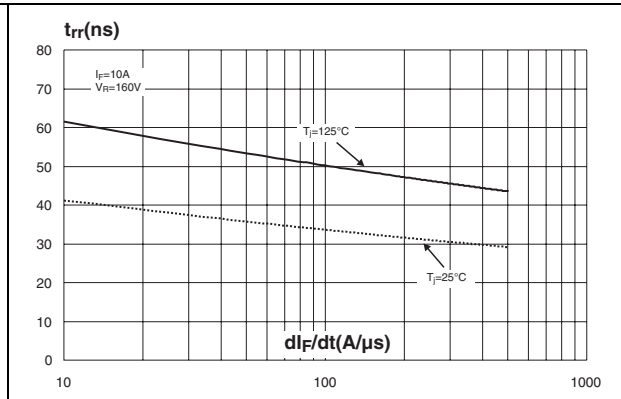

**Figure 9. Peak reverse recovery current versus  $di_F/dt$  (typical values, per diode)**

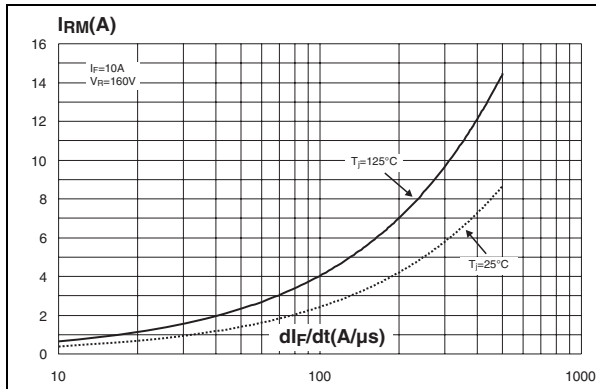

**Figure 10. Dynamic parameters versus junction temperature**

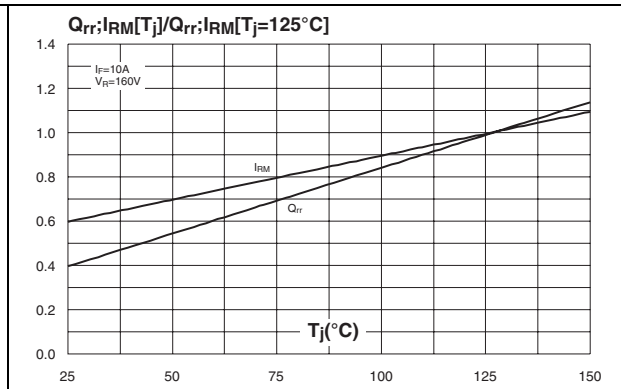

**Figure 11. Thermal resistance junction to ambient versus copper surface under tab (Epoxy printed circuit board FR4, copper thickness: 35 μm) for D<sup>2</sup>PAK**

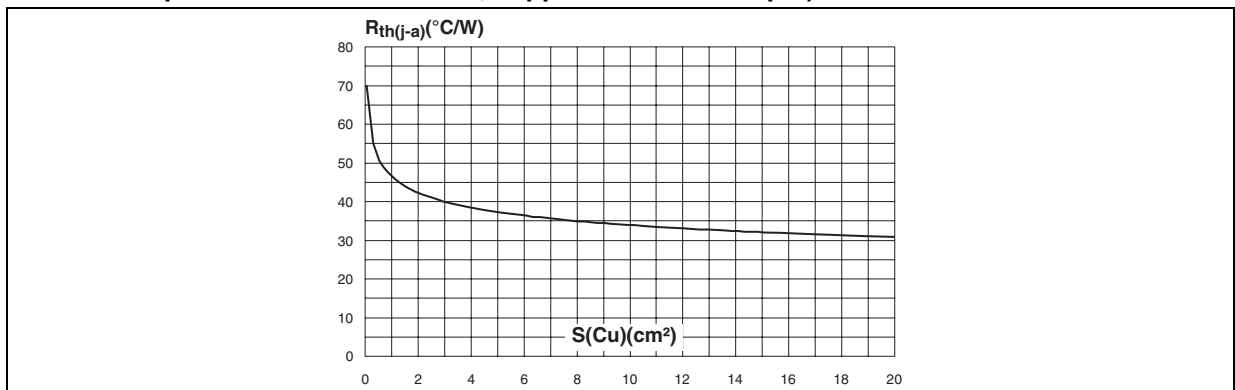

## 2 Package information

- Epoxy meets UL94, V0
- Cooling method: by conduction (C)
- Recommended torque value : 0.4 to 0.6 N·m

In order to meet environmental requirements, ST offers these devices in different grades of ECOPACK® packages, depending on their level of environmental compliance. ECOPACK® specifications, grade definitions and product status are available at: [www.st.com](http://www.st.com). ECOPACK® is an ST trademark.

**Table 6. I<sup>2</sup>PAK dimensions**

Ref.	Dimensions			
	Millimeters		Inches	
	Min.	Max.	Min.	Max.
A	4.40	4.60	0.173	0.181
A1	2.40	2.72	0.094	0.107
b	0.61	0.88	0.024	0.035
b1	1.14	1.70	0.044	0.067
c	0.49	0.70	0.019	0.028
c2	1.23	1.32	0.048	0.052
D	8.95	9.35	0.352	0.368
e	2.40	2.70	0.094	0.106
e1	4.95	5.15	0.195	0.203
E	10	10.40	0.394	0.409
L	13	14	0.512	0.551
L1	3.50	3.93	0.138	0.155
L2	1.27	1.40	0.050	0.055

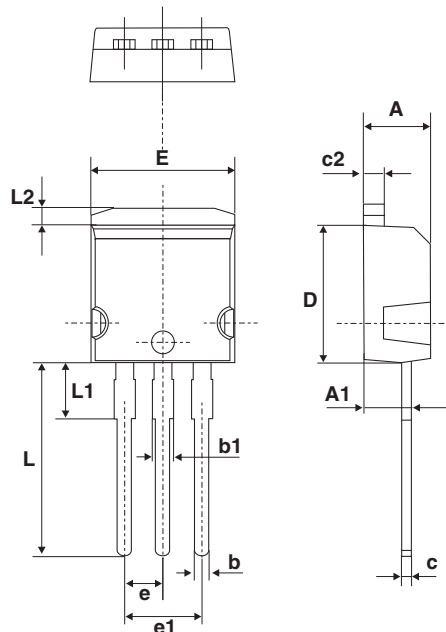

Table 7. D<sup>2</sup>PAK dimensions

Ref.	Dimensions					
	Millimeters			Inches		
	Min.	Typ.	Max.	Min.	Typ.	Max.
A	4.30		4.60	0.169		0.181
A1	2.49		2.69	0.098		0.106
A2	0.03		0.23	0.001		0.009
B	0.70		0.93	0.027		0.037
B2	1.25	1.40		0.048	0.055	
C	0.45		0.60	0.017		0.024
C2	1.21		1.36	0.047		0.054
D	8.95		9.35	0.352		0.368
E	10.00		10.28	0.393		0.405
G	4.88		5.28	0.192		0.208
L	15.00		15.85	0.590		0.624
L2	1.27		1.40	0.050		0.055
L3	1.40		1.75	0.055		0.069
R	0.40			0.016		
V2	0°		8°	0°		8°

Figure 12. Footprint (dimensions in mm)

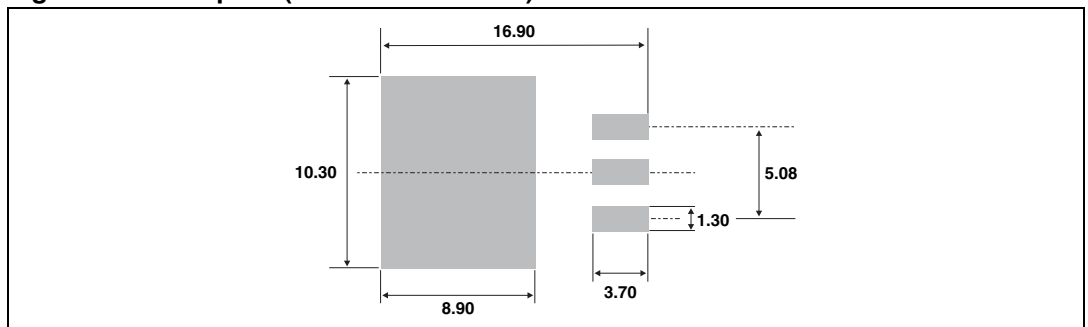

Table 8. TO-220AB dimensions

Ref.	Dimensions			
	Millimeters		Inches	
	Min.	Max.	Min.	Max.
A	4.40	4.60	0.173	0.181
C	1.23	1.32	0.048	0.051
D	2.40	2.72	0.094	0.107
E	0.49	0.70	0.019	0.027
F	0.61	0.88	0.024	0.034
F1	1.14	1.70	0.044	0.066
F2	1.14	1.70	0.044	0.066
G	4.95	5.15	0.194	0.202
G1	2.40	2.70	0.094	0.106
H2	10	10.40	0.393	0.409
L2	16.4 typ.		0.645 typ.	
L4	13	14	0.511	0.551
L5	2.65	2.95	0.104	0.116
L6	15.25	15.75	0.600	0.620
L7	6.20	6.60	0.244	0.259
L9	3.50	3.93	0.137	0.154
M	2.6 typ.		0.102 typ.	
Diam.	3.75	3.85	0.147	0.151

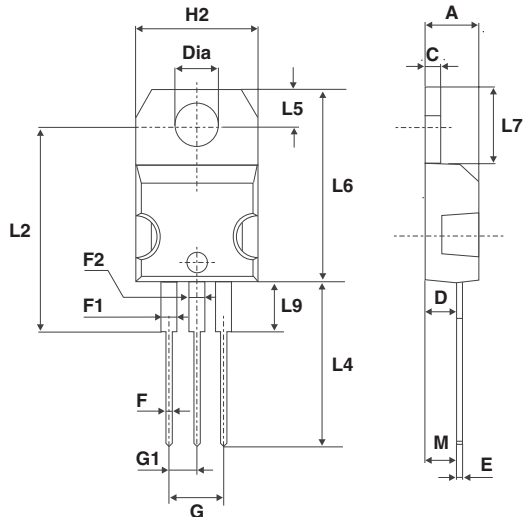



Table 9. TO-220FPAB dimensions

Ref.	Dimensions			
	Millimeters		Inches	
	Min.	Max.	Min.	Max.
A	4.4	4.6	0.173	0.181
B	2.5	2.7	0.098	0.106
D	2.5	2.75	0.098	0.108
E	0.45	0.70	0.018	0.027
F	0.75	1	0.030	0.039
F1	1.15	1.5	0.045	0.059
F2	1.15	1.5	0.045	0.059
G	4.95	5.20	0.195	0.205
G1	2.4	2.7	0.094	0.106
H	10	10.4	0.393	0.409
L2	16 Typ.		0.63 Typ.	
L3	28.6	30.6	1.126	1.205
L4	9.8	10.6	0.386	0.417
L5	2.9	3.6	0.114	0.142
L6	15.9	16.4	0.626	0.646
L7	9.00	9.30	0.354	0.366
Dia.	3.00	3.20	0.118	0.126

### 3 Ordering information

**Table 10. Ordering information**

Order code	Marking	Package	Weight	Base qty	Delivery mode
STTH2002CT	STTH2002CT	TO-220AB	2.23 g	50	Tube
STTH2002CG	STTH2002CG	D <sup>2</sup> PAK	1.48 g	50	Tube
STTH2002CG-TR	STTH2002CG	D <sup>2</sup> PAK	1.48 g	1000	Tape and reel
STTH2002CR	STTH2002CR	I <sup>2</sup> PAK	1.49 g	50	Tube
STTH2002CFP	STTH2002CFP	TO-220AB	1.70 g	50	Tube

### 4 Revision history

**Table 11. Document revision history**

Date	Revision	Changes
Feb-2004	1	First issue.
23-Jun-2010	2	Updated <a href="#">Table 1</a> . Updated ECOPACK statement.

**Please Read Carefully:**

Information in this document is provided solely in connection with ST products. STMicroelectronics NV and its subsidiaries ("ST") reserve the right to make changes, corrections, modifications or improvements, to this document, and the products and services described herein at any time, without notice.

All ST products are sold pursuant to ST's terms and conditions of sale.

Purchasers are solely responsible for the choice, selection and use of the ST products and services described herein, and ST assumes no liability whatsoever relating to the choice, selection or use of the ST products and services described herein.

No license, express or implied, by estoppel or otherwise, to any intellectual property rights is granted under this document. If any part of this document refers to any third party products or services it shall not be deemed a license grant by ST for the use of such third party products or services, or any intellectual property contained therein or considered as a warranty covering the use in any manner whatsoever of such third party products or services or any intellectual property contained therein.

**UNLESS OTHERWISE SET FORTH IN ST'S TERMS AND CONDITIONS OF SALE ST DISCLAIMS ANY EXPRESS OR IMPLIED WARRANTY WITH RESPECT TO THE USE AND/OR SALE OF ST PRODUCTS INCLUDING WITHOUT LIMITATION IMPLIED WARRANTIES OF MERCHANTABILITY, FITNESS FOR A PARTICULAR PURPOSE (AND THEIR EQUIVALENTS UNDER THE LAWS OF ANY JURISDICTION), OR INFRINGEMENT OF ANY PATENT, COPYRIGHT OR OTHER INTELLECTUAL PROPERTY RIGHT.**

**UNLESS EXPRESSLY APPROVED IN WRITING BY AN AUTHORIZED ST REPRESENTATIVE, ST PRODUCTS ARE NOT RECOMMENDED, AUTHORIZED OR WARRANTED FOR USE IN MILITARY, AIR CRAFT, SPACE, LIFE SAVING, OR LIFE SUSTAINING APPLICATIONS, NOR IN PRODUCTS OR SYSTEMS WHERE FAILURE OR MALFUNCTION MAY RESULT IN PERSONAL INJURY, DEATH, OR SEVERE PROPERTY OR ENVIRONMENTAL DAMAGE. ST PRODUCTS WHICH ARE NOT SPECIFIED AS "AUTOMOTIVE GRADE" MAY ONLY BE USED IN AUTOMOTIVE APPLICATIONS AT USER'S OWN RISK.**

Resale of ST products with provisions different from the statements and/or technical features set forth in this document shall immediately void any warranty granted by ST for the ST product or service described herein and shall not create or extend in any manner whatsoever, any liability of ST.

ST and the ST logo are trademarks or registered trademarks of ST in various countries.

Information in this document supersedes and replaces all information previously supplied.

The ST logo is a registered trademark of STMicroelectronics. All other names are the property of their respective owners.

© 2010 STMicroelectronics - All rights reserved

STMicroelectronics group of companies

Australia - Belgium - Brazil - Canada - China - Czech Republic - Finland - France - Germany - Hong Kong - India - Israel - Italy - Japan - Malaysia - Malta - Morocco - Philippines - Singapore - Spain - Sweden - Switzerland - United Kingdom - United States of America

[www.st.com](http://www.st.com)