

NTB25P06

Power MOSFET

-60 V, -27.5 A, P-Channel D²PAK

Designed for low voltage, high speed switching applications and to withstand high energy in the avalanche and commutation modes.

Features

- Pb-Free Packages are Available

Typical Applications

- PWM Motor Controls
- Power Supplies
- Converters
- Bridge Circuits

MAXIMUM RATINGS (T_J = 25°C unless otherwise noted)

Rating	Symbol	Value	Unit
Drain-to-Source Voltage	V _{DSS}	-60	V
Gate-to-Source Voltage	V _{GS}	± 15	V
- Continuous	V _{GSM}	± 20	Vpk
- Non-Repetitive (t _p ≤ 10 ms)			
Drain Current	I _D	27.5	A
- Continuous @ T _A = 25°C	I _{DM}	80	Apk
- Single Pulse (t _p ≤ 10 μs)			
Total Power Dissipation @ T _A = 25°C	P _D	120	W
Operating and Storage Temperature Range	T _J , T _{stg}	-55 to +175	°C
Single Pulse Drain-to-Source Avalanche Energy - Starting T _J = 25°C (V _{DD} = 25 V, V _{GS} = 10 V, I _{L(pk)} = 20 A, L = 3 mH, R _G = 25 Ω)	E _{AS}	600	mJ
Thermal Resistance			°C/W
- Junction-to-Case	R _{θJC}	1.25	
- Junction-to-Ambient (Note 1)	R _{θJA}	46.8	
- Junction-to-Ambient (Note 2)	R _{θJA}	63.2	
Maximum Lead Temperature for Soldering Purposes, (1/8" from case for 10 s)	T _L	260	°C

Maximum ratings are those values beyond which device damage can occur. Maximum ratings applied to the device are individual stress limit values (not normal operating conditions) and are not valid simultaneously. If these limits are exceeded, device functional operation is not implied, damage may occur and reliability may be affected.

1. When surface mounted to an FR4 board using 1" pad size (Cu Area 1.127 in²).
2. When surface mounted to an FR4 board using the minimum recommended pad size (Cu Area 0.412 in²).



ON Semiconductor®

<http://onsemi.com>

V _{(BR)DSS}	R _{DS(on)} TYP	I _D MAX
-60 V	65 mΩ @ -10 V	-27.5 A

P-Channel

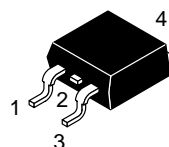
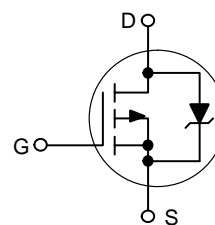

D²PAK
CASE 418B
STYLE 2

MARKING DIAGRAM & PIN ASSIGNMENT

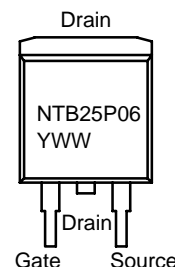

NTB25P06 = Device Code
Y = Year
WW = Work Week

ORDERING INFORMATION

Device	Package	Shipping [†]
NTB25P06	D ² PAK	50 Units/Rail
NTB25P06G	D ² PAK (Pb-Free)	50 Units/Rail
NTB25P06T4	D ² PAK	800/Tape & Reel
NTB25P06T4G	D ² PAK (Pb-Free)	800/Tape & Reel

[†]For information on tape and reel specifications, including part orientation and tape sizes, please refer to our Tape and Reel Packaging Specifications Brochure, BRD8011/D.

NTB25P06

ELECTRICAL CHARACTERISTICS (T_C = 25°C unless otherwise noted)

Characteristic	Symbol	Min	Typ	Max	Unit
OFF CHARACTERISTICS					
Drain-to-Source Breakdown Voltage (Note 3) (V _{GS} = 0 V, I _D = -250 μA) (Positive Temperature Coefficient)	V _{(BR)DSS}	-60 -	- 64	- -	V mV/°C
Zero Gate Voltage Drain Current (V _{GS} = 0 V, V _{DS} = -60 V, T _J = 25°C) (V _{GS} = 0 V, V _{DS} = -60 V, T _J = 150°C)	I _{DSS}	- -	- -	-10 -100	μA
Gate-Body Leakage Current (V _{GS} = ±15 V, V _{DS} = 0 V)	I _{GSS}	-	-	±100	nA

ON CHARACTERISTICS (Note 3)

Gate Threshold Voltage (V _{DS} = V _{GS} , I _D = -250 μA) (Negative Threshold Temperature Coefficient)	V _{GS(th)}	-2.0 -	-2.8 6.2	-4.0 -	V mV/°C
Static Drain-Source On-State Resistance (V _{GS} = -10 V, I _D = -12.5 A) (V _{GS} = -10 V, I _D = -25 A)	R _{DS(on)}	- -	0.065 0.070	0.075 0.082	Ω
Forward Transconductance (V _{DS} = -10 V, I _D = -12.5 A)	g _{FS}	-	13	-	Mhos

DYNAMIC CHARACTERISTICS

Input Capacitance	(V _{DS} = -25 V, V _{GS} = 0 V, F = 1.0 MHz)	C _{iss}	-	1200	1680	pF
Output Capacitance		C _{oss}	-	345	480	
Reverse Transfer Capacitance		C _{rss}	-	90	180	

SWITCHING CHARACTERISTICS (Notes 3 & 4)

Turn-On Delay Time	(V _{DD} = -30 V, I _D = -25 A, V _{GS} = -10 V R _G = 9.1 Ω)	t _{d(on)}	-	14	24	ns
Rise Time		t _r	-	72	118	ns
Turn-Off Delay Time		t _{d(off)}	-	43	68	ns
Fall Time		t _f	-	190	320	ns
Gate Charge	(V _{DS} = -48 V, I _D = -25 A, V _{GS} = -10 V)	Q _T	-	33	50	nC
		Q ₁	-	6.5	-	
		Q ₂	-	15	-	

BODY-DRAIN DIODE RATINGS (Note 3)

Diode Forward On-Voltage	(I _S = -25 A, V _{GS} = 0 V) (I _S = -25 A, V _{GS} = 0 V, T _J = 150°C)	V _{SD}	- -	-1.8 -1.4	-2.5 -	V
Reverse Recovery Time	(I _S = -25 A, V _{GS} = 0 V, di _S /dt = 100 A/μs)	t _{rr}	-	70	-	ns
		t _a	-	50	-	
		t _b	-	20	-	
Reverse Recovery Stored Charge		Q _{RR}	-	0.2	-	μC

3. Indicates Pulse Test: Pulse Width ≤ 300 μs, Duty Cycle ≤ 2%.

4. Switching characteristics are independent of operating junction temperatures.

NTB25P06

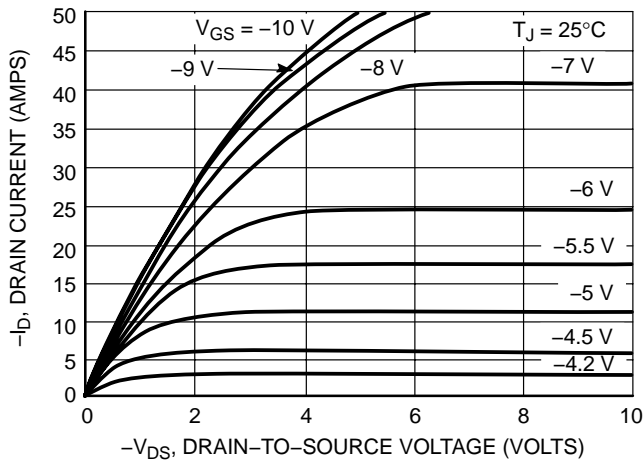

Figure 1. On-Region Characteristics

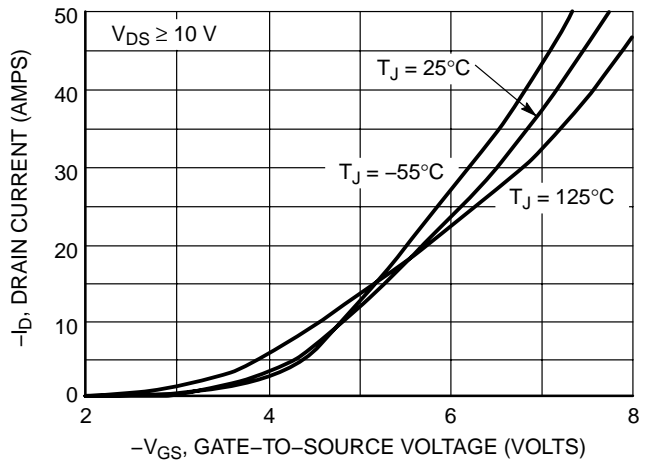

Figure 2. Transfer Characteristics

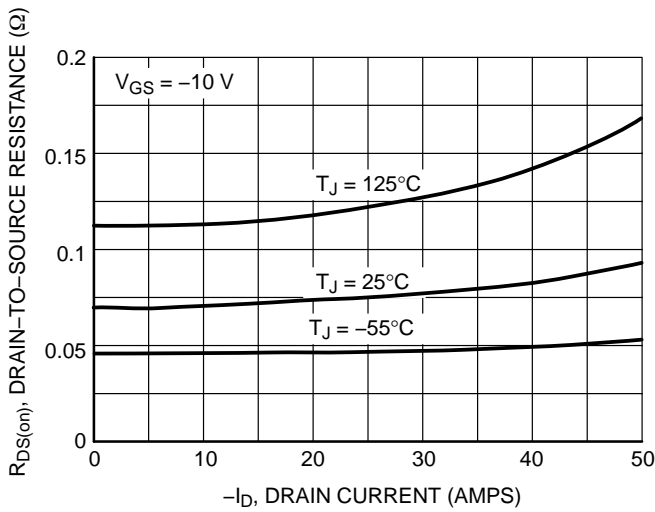

Figure 3. On-Resistance vs. Drain Current and Temperature

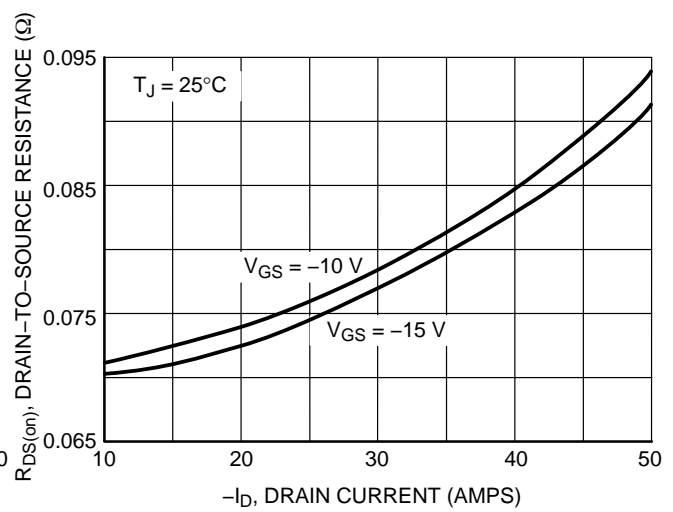

Figure 4. On-Resistance vs. Drain Current and Gate Voltage

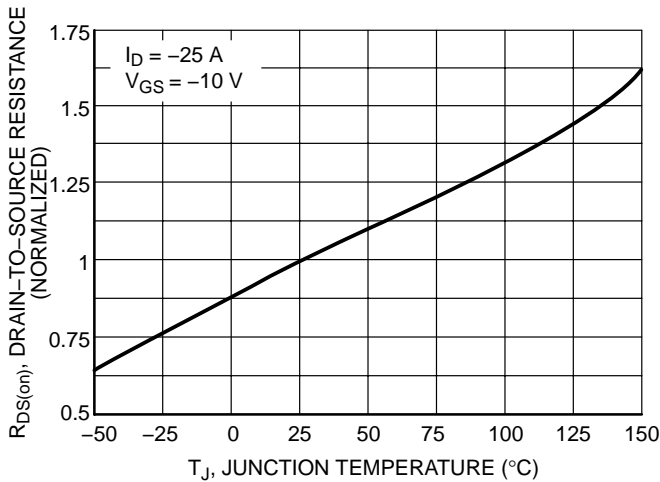

Figure 5. On-Resistance Variation with Temperature

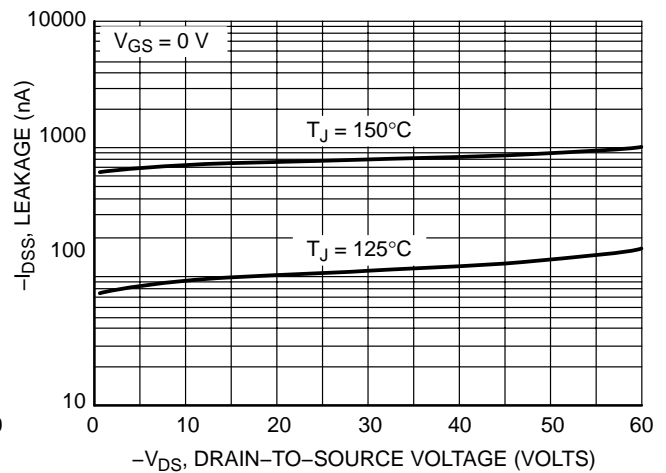

Figure 6. Drain-to-Source Leakage Current vs. Voltage

NTB25P06

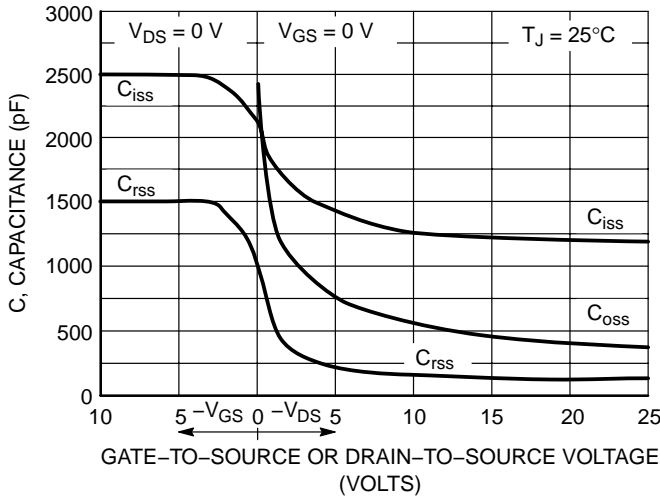

Figure 7. Capacitance Variation

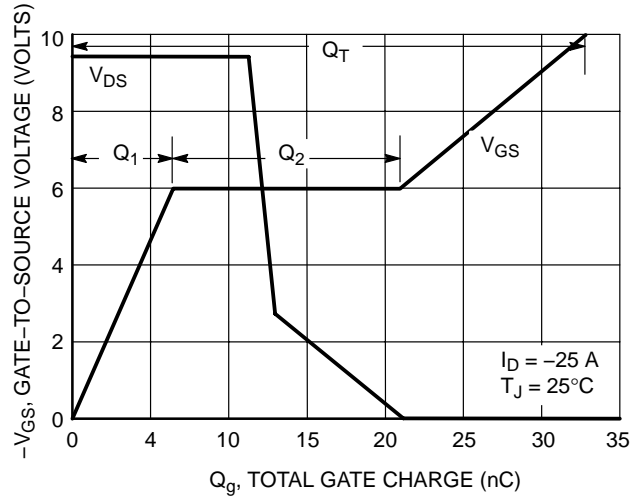

Figure 8. Gate-to-Source and Drain-to-Source Voltage vs. Total Charge

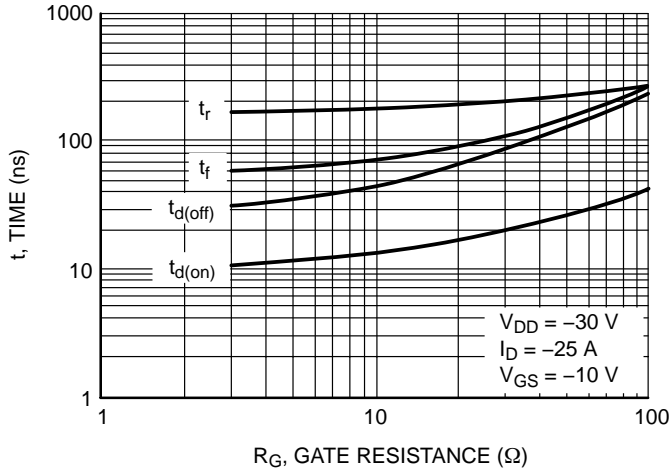

Figure 9. Resistive Switching Time Variation vs. Gate Resistance

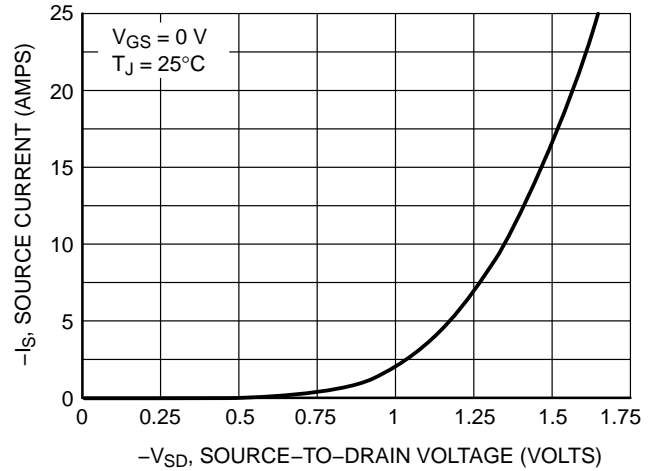

Figure 10. Diode Forward Voltage vs. Current

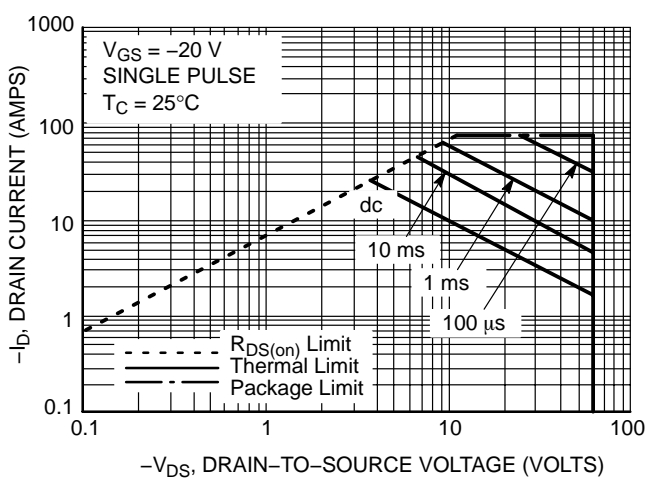

Figure 11. Maximum Rated Forward Biased Safe Operating Area

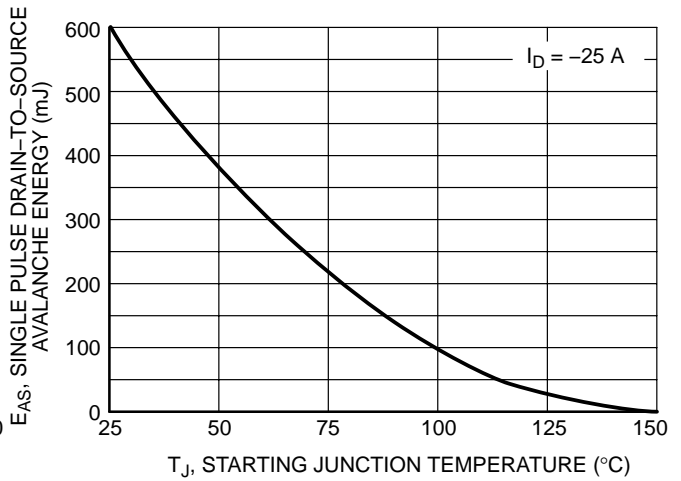
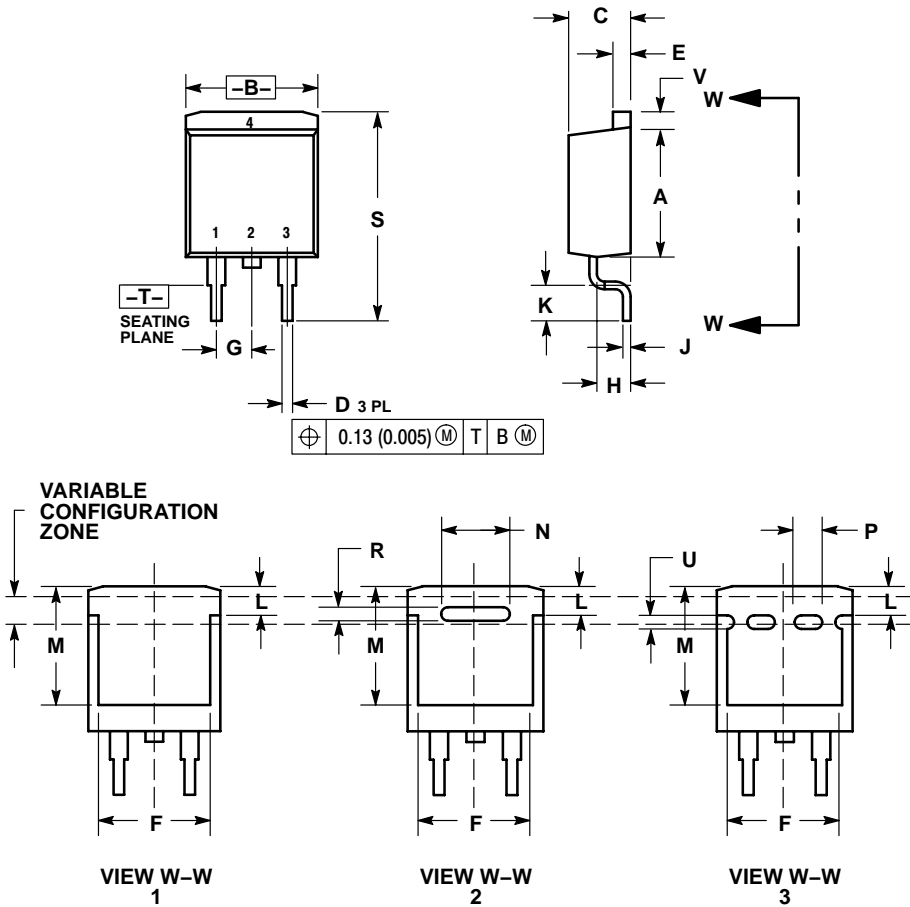

Figure 12. Maximum Avalanche Energy vs. Starting Junction Temperature

NTB25P06

PACKAGE DIMENSIONS

D²PAK
CASE 418B-04
ISSUE H



NOTES:

1. DIMENSIONING AND TOLERANCING PER ANSI Y14.5M, 1982.
2. CONTROLLING DIMENSION: INCH.
3. 418B-01 THRU 418B-03 OBSOLETE, NEW STANDARD 418B-04.

DIM	INCHES		MILLIMETERS	
	MIN	MAX	MIN	MAX
A	0.340	0.380	8.64	9.65
B	0.380	0.405	9.65	10.29
C	0.160	0.190	4.06	4.83
D	0.020	0.035	0.51	0.89
E	0.045	0.055	1.14	1.40
F	0.310	0.350	7.87	8.89
G	0.100 BSC		2.54 BSC	
H	0.080	0.110	2.03	2.79
J	0.018	0.025	0.46	0.64
K	0.090	0.110	2.29	2.79
L	0.052	0.072	1.32	1.83
M	0.280	0.320	7.11	8.13
N	0.197 REF		5.00 REF	
P	0.079 REF		2.00 REF	
R	0.039 REF		0.99 REF	
S	0.575	0.625	14.60	15.88
V	0.045	0.055	1.14	1.40

STYLE 2:

1. GATE
2. DRAIN
3. SOURCE
4. DRAIN

SOLDERING FOOTPRINT*

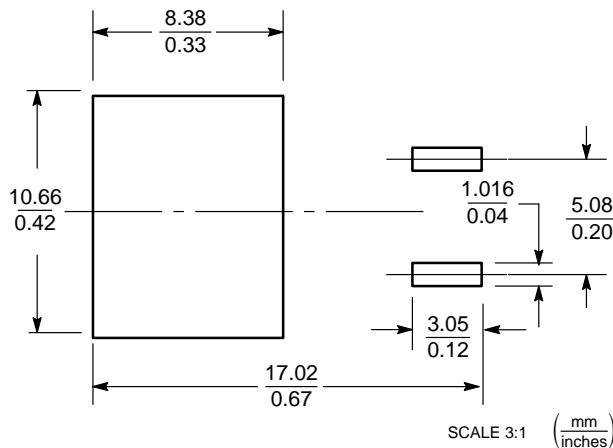

*For additional information on our Pb-Free strategy and soldering details, please download the ON Semiconductor Soldering and Mounting Techniques Reference Manual, SOLDERRM/D.

NTB25P06

ON Semiconductor and  are registered trademarks of Semiconductor Components Industries, LLC (SCILLC). SCILLC reserves the right to make changes without further notice to any products herein. SCILLC makes no warranty, representation or guarantee regarding the suitability of its products for any particular purpose, nor does SCILLC assume any liability arising out of the application or use of any product or circuit, and specifically disclaims any and all liability, including without limitation special, consequential or incidental damages. "Typical" parameters which may be provided in SCILLC data sheets and/or specifications can and do vary in different applications and actual performance may vary over time. All operating parameters, including "Typicals" must be validated for each customer application by customer's technical experts. SCILLC does not convey any license under its patent rights nor the rights of others. SCILLC products are not designed, intended, or authorized for use as components in systems intended for surgical implant into the body, or other applications intended to support or sustain life, or for any other application in which the failure of the SCILLC product could create a situation where personal injury or death may occur. Should Buyer purchase or use SCILLC products for any such unintended or unauthorized application, Buyer shall indemnify and hold SCILLC and its officers, employees, subsidiaries, affiliates, and distributors harmless against all claims, costs, damages, and expenses, and reasonable attorney fees arising out of, directly or indirectly, any claim of personal injury or death associated with such unintended or unauthorized use, even if such claim alleges that SCILLC was negligent regarding the design or manufacture of the part. SCILLC is an Equal Opportunity/Affirmative Action Employer. This literature is subject to all applicable copyright laws and is not for resale in any manner.

PUBLICATION ORDERING INFORMATION

LITERATURE FULFILLMENT:

Literature Distribution Center for ON Semiconductor
P.O. Box 5163, Denver, Colorado 80217 USA

Phone: 303-675-2175 or 800-344-3860 Toll Free USA/Canada

Fax: 303-675-2176 or 800-344-3867 Toll Free USA/Canada

Email: orderlit@onsemi.com

N. American Technical Support: 800-282-9855 Toll Free
USA/Canada

Japan: ON Semiconductor, Japan Customer Focus Center
2-9-1 Kamimeguro, Meguro-ku, Tokyo, Japan 153-0051
Phone: 81-3-5773-3850

ON Semiconductor Website: <http://onsemi.com>

Order Literature: <http://www.onsemi.com/litorder>

For additional information, please contact your
local Sales Representative.