

# MMQA Quad Common Anode Series

Preferred Devices

## SC-74 Quad Monolithic Common Anode

### Transient Voltage Suppressors for ESD Protection

This quad monolithic silicon voltage suppressor is designed for applications requiring transient overvoltage protection capability. It is intended for use in voltage and ESD sensitive equipment such as computers, printers, business machines, communication systems, medical equipment, and other applications. Its quad junction common anode design protects four separate lines using only one package. These devices are ideal for situations where board space is at a premium.

#### Specification Features:

- SC-74 Package Allows Four Separate Unidirectional Configurations
- Peak Power – Min. 24 W @ 1.0 ms (Unidirectional), per Figure 5 Waveform
- Peak Power – Min. 150 W @ 20  $\mu$ s (Unidirectional), per Figure 6 Waveform
- Maximum Clamping Voltage @ Peak Pulse Current
- Low Leakage < 2.0  $\mu$ A
- ESD Rating of Class N (exceeding 16 kV) per the Human Body Model
- Pb-Free Packages are Available

#### THERMAL CHARACTERISTICS ( $T_A = 25^\circ\text{C}$ unless otherwise noted)

Characteristic	Symbol	Value	Unit
Peak Power Dissipation @ 1.0 ms (Note 1) @ $T_A \leq 25^\circ\text{C}$	$P_{pk}$	24	W
Peak Power Dissipation @ 20 $\mu$ s (Note 2) @ $T_A \leq 25^\circ\text{C}$	$P_{pk}$	150	W
Total Power Dissipation on FR-5 Board (Note 3) @ $T_A = 25^\circ\text{C}$	$P_D$	225 1.8	mW mW/ $^\circ\text{C}$
Thermal Resistance from Junction-to-Ambient	$R_{\theta JA}$	556	$^\circ\text{C}/\text{W}$
Total Power Dissipation on Alumina Substrate (Note 4) @ $T_A = 25^\circ\text{C}$ Derate above $25^\circ\text{C}$	$P_D$	300 2.4	mW mW/ $^\circ\text{C}$
Thermal Resistance from Junction-to-Ambient	$R_{\theta JA}$	417	$^\circ\text{C}/\text{W}$
Junction and Storage Temperature Range	$T_J, T_{stg}$	-55 to +150	$^\circ\text{C}$
Lead Solder Temperature – Maximum (10 Second Duration)	$T_L$	260	$^\circ\text{C}$



ON Semiconductor®

<http://onsemi.com>

## SC-74 QUAD TRANSIENT VOLTAGE SUPPRESSOR 24 WATTS PEAK POWER 5.6 – 33 VOLTS

#### PIN ASSIGNMENT



SC-74  
PLASTIC  
CASE 318F

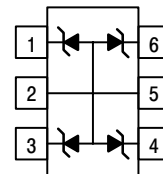

PIN 1. CATHODE  
2. ANODE  
3. CATHODE  
4. ANODE  
5. ANODE  
6. CATHODE

#### MARKING DIAGRAM

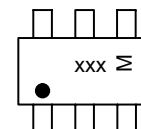

xxx = Device Code  
M = Date Code

#### ORDERING INFORMATION

See detailed ordering and shipping information in the table on page 5 of this data sheet.

#### DEVICE MARKING INFORMATION

See specific marking information in the device marking table on page 5 of this data sheet.

Preferred devices are recommended choices for future use and best overall value.

# MMQA Quad Common Anode Series

## ELECTRICAL CHARACTERISTICS ( $T_A = 25^\circ\text{C}$ unless otherwise noted)

### UNIDIRECTIONAL

(Circuit tied to pins 1, 2, and 5; Pins 2, 3, and 5; Pins 2, 4, and 5; or Pins 2, 5, and 6) ( $V_F = 0.9\text{ V Max @ } I_F = 10\text{ mA}$ )

Device	Breakdown Voltage				Max Reverse Leakage Current		Max Zener Impedance (Note 7)	Max Reverse Surge Current	Max Reverse Voltage @ $I_{RSM}$ (Note 6) (Clamping Voltage)	Maximum Temperature Coefficient of $V_Z$	Capacitance @ 0 Volt Bias, 1 MHz	
	$V_{ZT}$ (Note 5) (V)			@ $I_{ZT}$	$I_R$	$V_R$					Min	Max
	Min	Nom	Max									
MMQA5V6T1,T3	5.32	5.6	5.88	1.0	2000	3.0	400	3.0	8.0	1.26	-	-
MMQA6V2T1,T3	5.89	6.2	6.51	1.0	700	4.0	300	2.66	9.0	10.6	-	-
MMQA6V8T1,T3	6.46	6.8	7.14	1.0	500	4.3	300	2.45	9.8	10.9	100	250
MMQA12VT1,T3	11.4	12	12.6	1.0	75	9.1	80	1.39	17.3	14	-	-
MMQA13VT1	12.4	13	13.7	1.0	75	9.8	80	1.29	18.6	15	-	-
MMQA15VT1,T3	14.3	15	15.8	1.0	75	11	80	1.1	21.7	16	-	-
MMQA18VT1,T3	17.1	18	18.9	1.0	75	14	80	0.923	26	19	-	-
MMQA20VT1,T3	19	20	21	1.0	75	15	80	0.84	28.6	20.1	-	-
MMQA21VT1,T3	20	21	22.1	1.0	75	16	80	0.792	30.3	21	-	-
MMQA22VT1,T3	20.9	22	23.1	1.0	75	17	80	0.758	31.7	22	-	-
MMQA24VT1,T3	22.8	24	25.2	1.0	75	18	100	0.694	34.6	25	-	-
MMQA27VT1,T3	25.7	27	28.4	1.0	75	21	125	0.615	39	28	-	-
MMQA30VT1,T3	28.5	30	31.5	1.0	75	23	150	0.554	43.3	32	-	-
MMQA33VT1,T3	31.4	33	34.7	1.0	75	25	200	0.504	48.6	37	-	-

1. Non-repetitive current pulse per Figure 5 and derate above  $T_A = 25^\circ\text{C}$  per Figure 4.
2. Non-repetitive current pulse per Figure 6 and derate above  $T_A = 25^\circ\text{C}$  per Figure 4.
3. FR-5 =  $1.0 \times 0.75 \times 0.62$  in.
4. Alumina =  $0.4 \times 0.3 \times 0.024$  in., 99.5% alumina
5.  $V_Z$  measured at pulse test current  $I_T$  at an ambient temperature of  $25^\circ\text{C}$ .
6. Surge current waveform per Figure 5 and derate per Figure 4.
7.  $Z_{ZT}$  is measured by dividing the AC voltage drop across the device by the AC current supplied. The specified limits are  $I_{Z(AC)} = 0.1 I_{Z(DC)}$ , with AC frequency = 1 kHz.

## TYPICAL CHARACTERISTICS

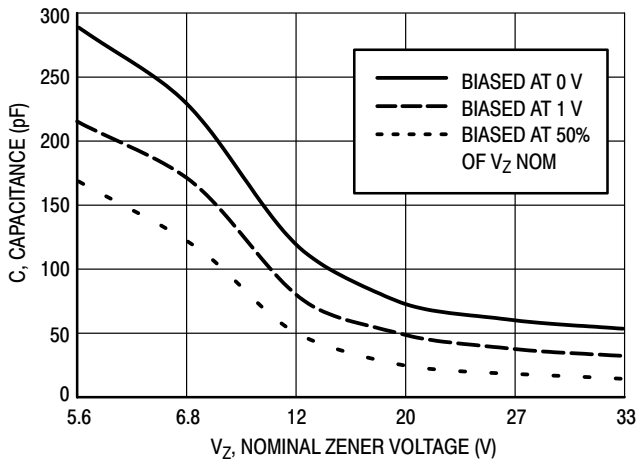

Figure 1. Typical Capacitance

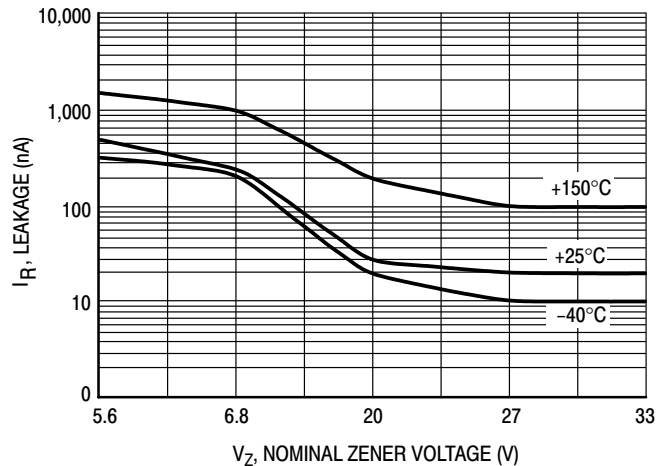

Figure 2. Typical Leakage Current

# MMQA Quad Common Anode Series

## TYPICAL CHARACTERISTICS

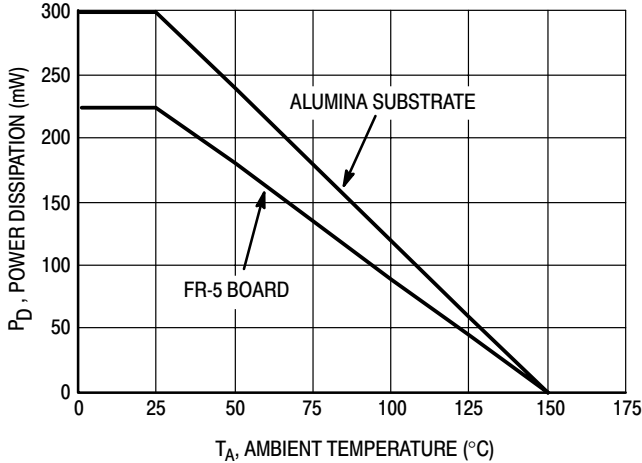

Figure 3. Steady State Power Derating Curve

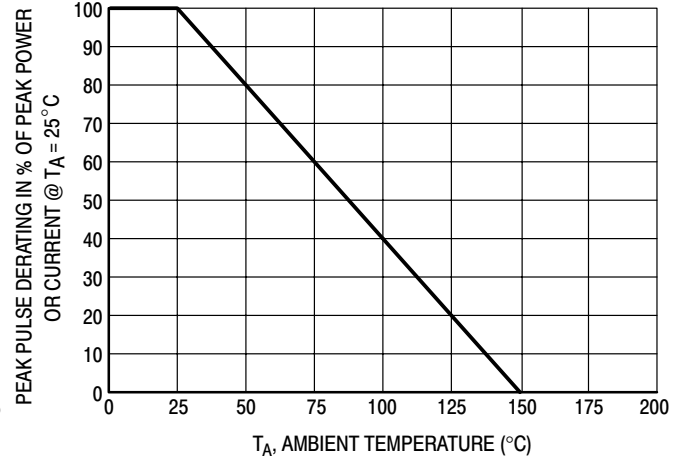

Figure 4. Pulse Derating Curve

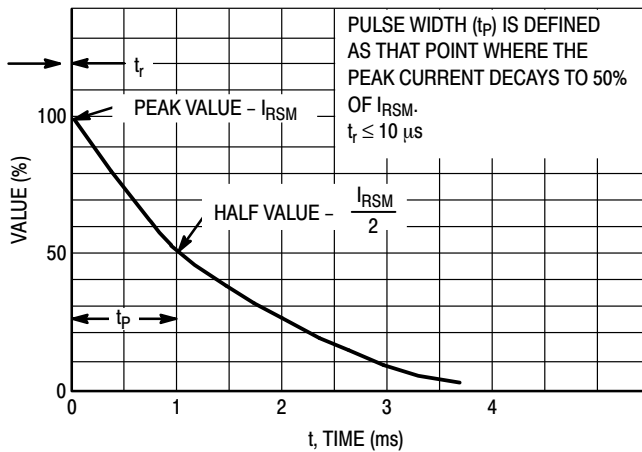

Figure 5. 10 × 1000 µs Pulse Waveform

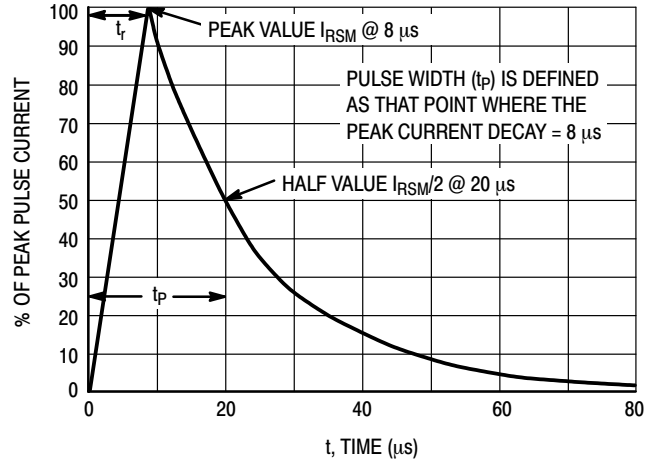

Figure 6. 8 × 20 µs Pulse Waveform

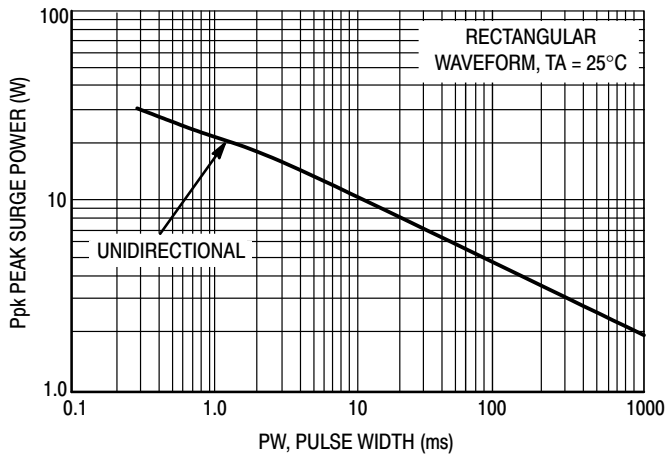

Figure 7. Maximum Non-Repetitive Surge Power, Ppk versus PW

Power is defined as  $V_{RSM} \times I_Z(pk)$  where  $V_{RSM}$  is the clamping voltage at  $I_Z(pk)$ .

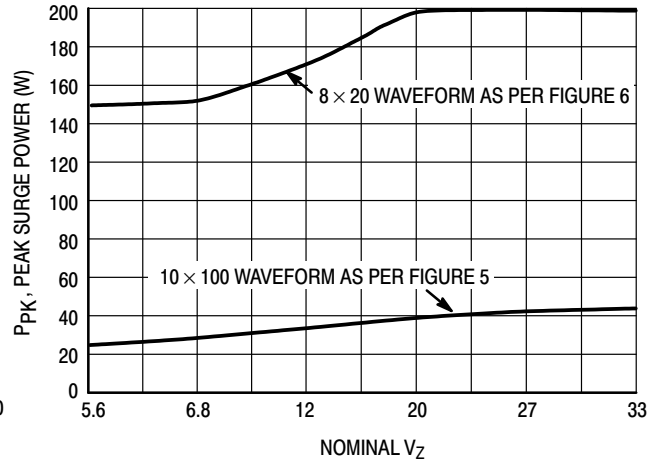

Figure 8. Typical Maximum Non-Repetitive Surge Power, Ppk versus  $V_{BR}$

# MMQA Quad Common Anode Series

## TYPICAL COMMON ANODE APPLICATIONS

A quad junction common anode design in a SC-74 package protects four separate lines using only one package. This adds flexibility and creativity to PCB design especially

when board space is at a premium. A simplified example of MMQA Series Device applications is illustrated below.

### Computer Interface Protection

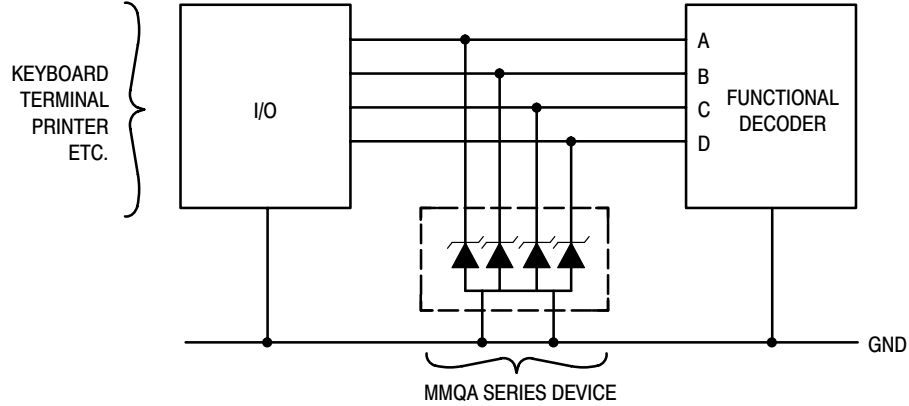

### Microprocessor Protection

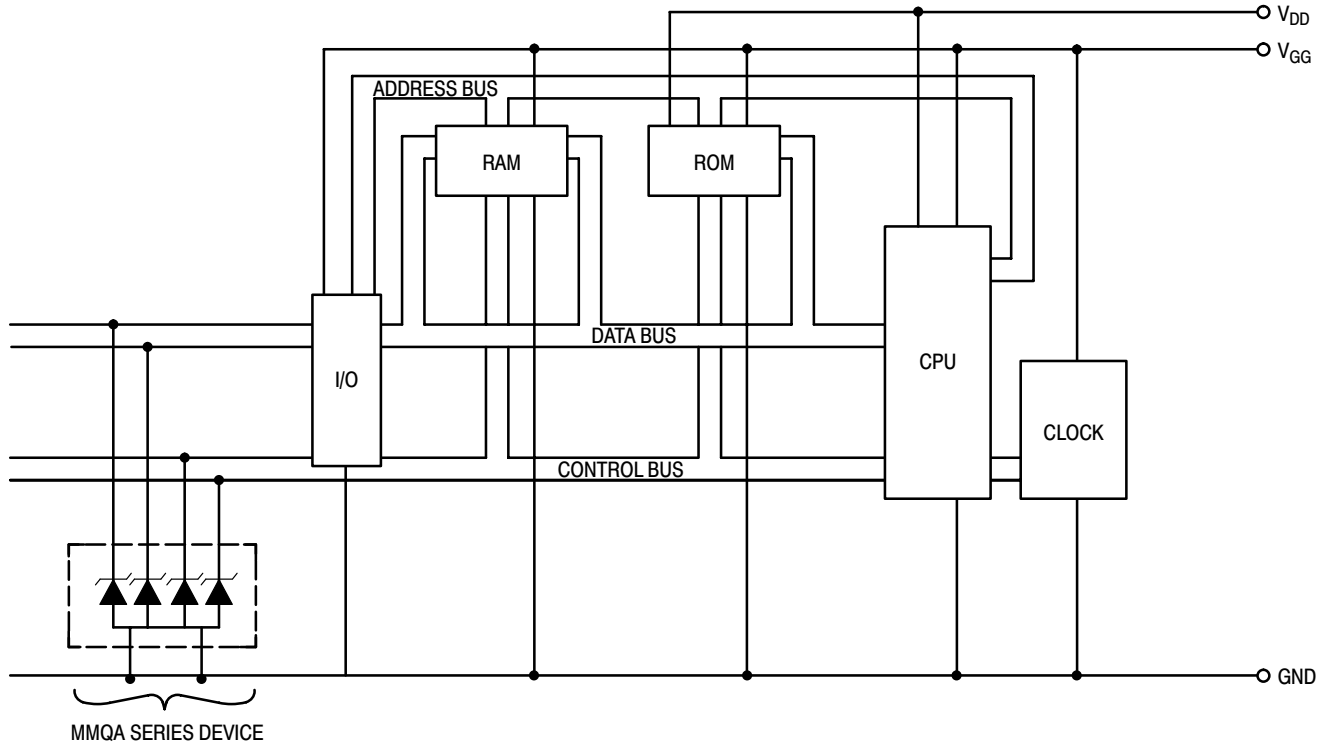

## MMQA Quad Common Anode Series

### DEVICE MARKING AND ORDERING INFORMATION

Device	Device Marking	Package	Shipping†
MMQA5V6T1	5A6	SC-74	3,000/Tape & Reel
MMQA5V6T3	5A6	SC-74	10,000/Tape & Reel
MMQA6V2T1	6A2	SC-74	3,000/Tape & Reel
MMQA6V2T1G	6A2	SC-74 (Pb-Free)	3,000/Tape & Reel
MMQA6V2T3	6A2	SC-74	10,000/Tape & Reel
MMQA6V8T1	6A8	SC-74	3,000/Tape & Reel
MMQA6V8T3	6A8	SC-74	10,000/Tape & Reel
MMQA12VT1	12A	SC-74	3,000/Tape & Reel
MMQA12VT1G	12A	SC-74 (Pb-Free)	3,000/Tape & Reel
MMQA12VT3	12A	SC-74	10,000/Tape & Reel
MMQA13VT1	13A	SC-74	3,000/Tape & Reel
MMQA15VT1	15A	SC-74	3,000/Tape & Reel
MMQA15VT3	15A	SC-74	10,000/Tape & Reel
MMQA18VT1	18A	SC-74	3,000/Tape & Reel
MMQA18VT3	18A	SC-74	10,000/Tape & Reel
MMQA20VT1	20A	SC-74	3,000/Tape & Reel
MMQA20VT3	20A	SC-74	10,000/Tape & Reel
MMQA20VT3G	20A	SC-74 (Pb-Free)	10,000/Tape & Reel
MMQA21VT1	21A	SC-74	3,000/Tape & Reel
MMQA21VT3	21A	SC-74	10,000/Tape & Reel
MMQA22VT1	22A	SC-74	3,000/Tape & Reel
MMQA22VT3	22A	SC-74	10,000/Tape & Reel
MMQA24VT1	24A	SC-74	3,000/Tape & Reel
MMQA24VT3	24A	SC-74	10,000/Tape & Reel
MMQA27VT1	27A	SC-74	3,000/Tape & Reel
MMQA27VT3	27A	SC-74	10,000/Tape & Reel
MMQA30VT1	30A	SC-74	3,000/Tape & Reel
MMQA30VT3	30A	SC-74	10,000/Tape & Reel
MMQA33VT1	33A	SC-74	3,000/Tape & Reel
MMQA33VT3	33A	SC-74	10,000/Tape & Reel

†For information on tape and reel specifications, including part orientation and tape sizes, please refer to our Tape and Reel Packaging Specifications Brochure, BRD8011/D.

#### Mechanical Characteristics:

**CASE:** Void-free, transfer-molded, thermosetting plastic case.

**FINISH:** Corrosion resistant finish, easily solderable.

Package designed for optimal automated board assembly.

Small package size for high density applications.

Available in 8 mm Tape and Reel.

Use the Device Number to order the 7 inch/3,000 unit reel.

Replace the "T1" with "T3" in the Device Number to order the

13 inch/10,000 unit reel.

# MMQA Quad Common Anode Series

## PACKAGE DIMENSIONS

### SC-74 CASE 318F-05 ISSUE K

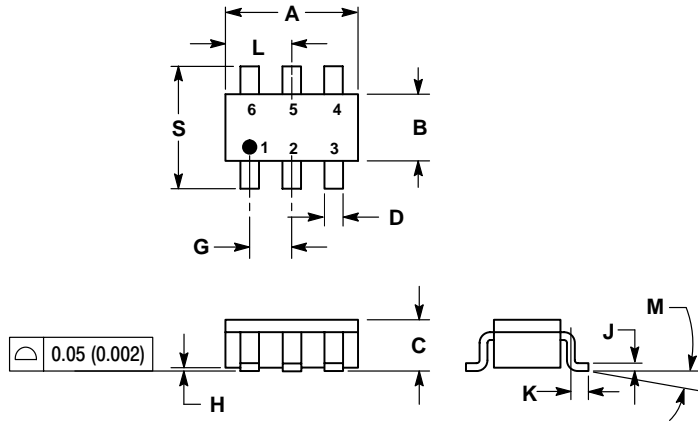

#### NOTES:

1. DIMENSIONING AND TOLERANCING PER ANSI Y14.5M, 1982.
2. CONTROLLING DIMENSION: INCH.
3. MAXIMUM LEAD THICKNESS INCLUDES LEAD FINISH THICKNESS. MINIMUM LEAD THICKNESS IS THE MINIMUM THICKNESS OF BASE MATERIAL.
4. 318F-01, -02, -03 OBSOLETE. NEW STANDARD 318F-04.

DIM	INCHES		MILLIMETERS	
	MIN	MAX	MIN	MAX
A	0.1142	0.1220	2.90	3.10
B	0.0512	0.0669	1.30	1.70
C	0.0354	0.0433	0.90	1.10
D	0.0098	0.0197	0.25	0.50
G	0.0335	0.0413	0.85	1.05
H	0.0005	0.0040	0.013	0.100
J	0.0040	0.0102	0.10	0.26
K	0.0079	0.0236	0.20	0.60
L	0.0493	0.0649	1.25	1.65
M	0°	10°	0°	10°
S	0.0985	0.1181	2.50	3.00

#### STYLE 1:

1. CATHODE
2. ANODE
3. CATHODE
4. CATHODE
5. ANODE
6. CATHODE

### SOLDERING FOOTPRINT\*

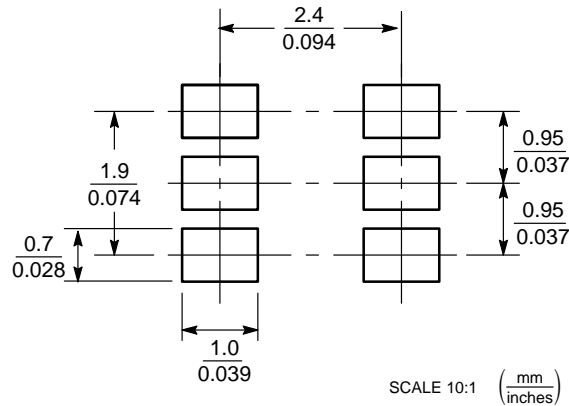

\*For additional information on our Pb-Free strategy and soldering details, please download the ON Semiconductor Soldering and Mounting Techniques Reference Manual, SOLDERRM/D.

ON Semiconductor and are registered trademarks of Semiconductor Components Industries, LLC (SCILLC). SCILLC reserves the right to make changes without further notice to any products herein. SCILLC makes no warranty, representation or guarantee regarding the suitability of its products for any particular purpose, nor does SCILLC assume any liability arising out of the application or use of any product or circuit, and specifically disclaims any and all liability, including without limitation special, consequential or incidental damages. "Typical" parameters which may be provided in SCILLC data sheets and/or specifications can and do vary in different applications and actual performance may vary over time. All operating parameters, including "Typicals" must be validated for each customer application by customer's technical experts. SCILLC does not convey any license under its patent rights nor the rights of others. SCILLC products are not designed, intended, or authorized for use as components in systems intended for surgical implant into the body, or other applications intended to support or sustain life, or for any other application in which the failure of the SCILLC product could create a situation where personal injury or death may occur. Should Buyer purchase or use SCILLC products for any such unintended or unauthorized application, Buyer shall indemnify and hold SCILLC and its officers, employees, subsidiaries, affiliates, and distributors harmless against all claims, costs, damages, and expenses, and reasonable attorney fees arising out of, directly or indirectly, any claim of personal injury or death associated with such unintended or unauthorized use, even if such claim alleges that SCILLC was negligent regarding the design or manufacture of the part. SCILLC is an Equal Opportunity/Affirmative Action Employer. This literature is subject to all applicable copyright laws and is not for resale in any manner.

### PUBLICATION ORDERING INFORMATION

#### LITERATURE FULFILLMENT:

Literature Distribution Center for ON Semiconductor  
P.O. Box 5163, Denver, Colorado 80217 USA

Phone: 303-675-2175 or 800-344-3860 Toll Free USA/Canada  
Fax: 303-675-2176 or 800-344-3867 Toll Free USA/Canada  
Email: orderlit@onsemi.com

N. American Technical Support: 800-282-9855 Toll Free  
USA/Canada

Japan: ON Semiconductor, Japan Customer Focus Center  
2-9-1 Kamimeguro, Meguro-ku, Tokyo, Japan 153-0051  
Phone: 81-3-5773-3850

ON Semiconductor Website: <http://onsemi.com>

Order Literature: <http://www.onsemi.com/litorder>

For additional information, please contact your local Sales Representative.