

# Silicon Carbide (SiC) MOSFET – EliteSiC, 33 mohm, 650 V, M2, TOLL

## NTBL045N065SC1

### Features

- Typ.  $R_{DS(on)} = 33\text{ m}\Omega @ V_{GS} = 18\text{ V}$   
Typ.  $R_{DS(on)} = 45\text{ m}\Omega @ V_{GS} = 15\text{ V}$
- Ultra Low Gate Charge ( $Q_{G(tot)} = 105\text{ nC}$ )
- Low Effective Output Capacitance ( $C_{oss} = 162\text{ pF}$ )
- 100% Avalanche Tested
- $T_J = 175^\circ\text{C}$
- RoHS Compliant

### Typical Applications

- SMPS (Switching Mode Power Supplies)
- Solar Inverters
- UPS (Uninterruptable Power Supplies)
- Energy Storage

### MAXIMUM RATINGS ( $T_J = 25^\circ\text{C}$ unless otherwise noted)

Parameter		Symbol	Value	Unit
Drain-to-Source Voltage		$V_{DSS}$	650	V
Gate-to-Source Voltage		$V_{GS}$	-8/+22.6	V
Recommended Operation Values of Gate – Source Voltage		$T_C < 175^\circ\text{C}$ $V_{GSop}$	-5/+18	V
Continuous Drain Current (Note 2)	Steady State $T_C = 25^\circ\text{C}$	$I_D$	73	A
Power Dissipation (Note 2)		$P_D$	348	W
Continuous Drain Current (Notes 1, 2)	Steady State $T_C = 100^\circ\text{C}$	$I_D$	51	A
Power Dissipation (Notes 1, 2)		$P_D$	174	W
Pulsed Drain Current (Note 3)		$T_C = 25^\circ\text{C}$ $I_{DM}$	182	A
Operating Junction and Storage Temperature Range		$T_J, T_{stg}$	-55 to +175	$^\circ\text{C}$
Source Current (Body Diode)		$I_S$	75	A
Single Pulse Drain-to-Source Avalanche Energy ( $I_L = 12\text{ A}_{pk}$ , $L = 1\text{ mH}$ ) (Note 4)		$E_{AS}$	72	mJ
Maximum Lead Temperature for Soldering, 1/8" from Case for 10 Seconds		$T_L$	260	$^\circ\text{C}$

Stresses exceeding those listed in the Maximum Ratings table may damage the device. If any of these limits are exceeded, device functionality should not be assumed, damage may occur and reliability may be affected.

1. Surface mounted on a FR-4 board using 1 in2 pad of 2 oz copper.
2. The entire application environment impacts the thermal resistance values shown, they are not constants and are only valid for the particular conditions noted.
3. Repetitive rating, limited by max junction temperature.
4.  $E_{AS}$  of 72 mJ is based on starting  $T_J = 25^\circ\text{C}$ ;  $L = 1\text{ mH}$ ,  $I_{AS} = 12\text{ A}$ ,  $V_{DD} = 50\text{ V}$ ,  $V_{GS} = 18\text{ V}$ .

$V_{DSS}$	$R_{DS(on)}\text{ MAX}$	$I_D\text{ MAX}$
650 V	50 m $\Omega$ @ 18 V	73 A

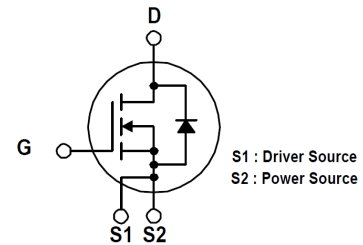

N-Channel MOSFET

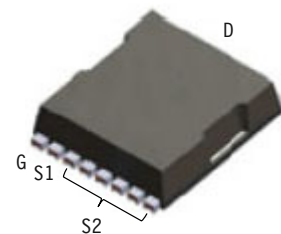

H-PSOF8L  
CASE 100DC

### MARKING DIAGRAM

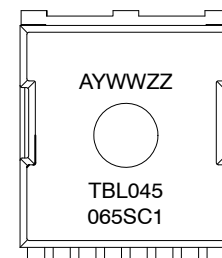

- A = Assembly Location
- Y = Year
- WW = Work Week
- ZZ = Assembly Lot Code
- TBL045065SC1 = Specific Device Code

### ORDERING INFORMATION

See detailed ordering and shipping information on page 6 of this data sheet.

# NTBL045N065SC1

## THERMAL CHARACTERISTICS

Parameter	Symbol	Max	Units
Junction-to-Case – Steady State (Note 2)	$R_{\theta JC}$	0.43	°C/W
Junction-to-Ambient – Steady State (Notes 1, 2)	$R_{\theta JA}$	43	°C/W

## ELECTRICAL CHARACTERISTICS ( $T_J = 25^\circ\text{C}$ unless otherwise stated)

Parameter	Symbol	Test Condition	Min	Typ	Max	Unit
<b>OFF CHARACTERISTICS</b>						
Drain-to-Source Breakdown Voltage	$V_{(BR)DSS}$	$V_{GS} = 0\text{ V}, I_D = 1\text{ mA}$	650			V
Drain-to-Source Breakdown Voltage Temperature Coefficient	$V_{(BR)DSS}/T_J$	$I_D = 20\text{ mA}$ , refer to $25^\circ\text{C}$		0.15		V/°C
Zero Gate Voltage Drain Current	$I_{DSS}$	$V_{GS} = 0\text{ V}$ $V_{DS} = 650\text{ V}$	$T_J = 25^\circ\text{C}$		10	$\mu\text{A}$
			$T_J = 175^\circ\text{C}$		1	mA
Gate-to-Source Leakage Current	$I_{GSS}$	$V_{GS} = +18/-5\text{ V}, V_{DS} = 0\text{ V}$			250	nA

## ON CHARACTERISTICS

Gate Threshold Voltage	$V_{GS(TH)}$	$V_{GS} = V_{DS}, I_D = 8\text{ mA}$	1.8	2.8	4.3	V
Recommended Gate Voltage	$V_{GOP}$		-5		+18	V
Drain-to-Source On Resistance	$R_{DS(on)}$	$V_{GS} = 15\text{ V}, I_D = 25\text{ A}, T_J = 25^\circ\text{C}$		45		m $\Omega$
		$V_{GS} = 18\text{ V}, I_D = 25\text{ A}, T_J = 25^\circ\text{C}$		33	50	
		$V_{GS} = 18\text{ V}, I_D = 25\text{ A}, T_J = 175^\circ\text{C}$		40		
Forward Transconductance	$g_{FS}$	$V_{DS} = 10\text{ V}, I_D = 25\text{ A}$		16		S

## CHARGES, CAPACITANCES & GATE RESISTANCE

Input Capacitance	$C_{ISS}$	$V_{GS} = 0\text{ V}, f = 1\text{ MHz},$ $V_{DS} = 325\text{ V}$		1870		pF
Output Capacitance	$C_{OSS}$			162		
Reverse Transfer Capacitance	$C_{RSS}$			14		
Total Gate Charge	$Q_{G(TOT)}$	$V_{GS} = -5/18\text{ V}, V_{DS} = 520\text{ V},$ $I_D = 25\text{ A}$		105		nC
Gate-to-Source Charge	$Q_{GS}$			27		
Gate-to-Drain Charge	$Q_{GD}$			30		
Gate-Resistance	$R_G$	$f = 1\text{ MHz}$		3.1		$\Omega$

## SWITCHING CHARACTERISTICS

Turn-On Delay Time	$t_{d(ON)}$	$V_{GS} = -5/18\text{ V}, V_{DS} = 400\text{ V},$ $I_D = 25\text{ A}, R_G = 2.2\ \Omega,$ Inductive Load		13		ns
Rise Time	$t_r$			14		
Turn-Off Delay Time	$t_{d(OFF)}$			26		
Fall Time	$t_f$			7		$\mu\text{J}$
Turn-On Switching Loss	$E_{ON}$			47		
Turn-Off Switching Loss	$E_{OFF}$			33		
Total Switching Loss	$E_{TOT}$			80		

## SOURCE-DRAIN DIODE CHARACTERISTICS

Continuous Source-Drain Diode Forward Current	$I_{SD}$	$V_{GS} = -5\text{ V}, T_J = 25^\circ\text{C}$			75	A
Pulsed Source-Drain Diode Forward Current (Note 3)	$I_{SDM}$	$V_{GS} = -5\text{ V}, T_J = 25^\circ\text{C}$			182	A
Forward Diode Voltage	$V_{SD}$	$V_{GS} = -5\text{ V}, I_{SD} = 25\text{ A}, T_J = 25^\circ\text{C}$		4.4		V

# NTBL045N065SC1

## ELECTRICAL CHARACTERISTICS (T<sub>J</sub> = 25°C unless otherwise stated)

Parameter	Symbol	Test Condition	Min	Typ	Max	Unit
-----------	--------	----------------	-----	-----	-----	------

### SOURCE-DRAIN DIODE CHARACTERISTICS

Reverse Recovery Time	t <sub>RR</sub>	V <sub>GS</sub> = -5/18 V, I <sub>SD</sub> = 25 A, dI <sub>S</sub> /dt = 1000 A/μs		20		ns
Reverse Recovery Charge	Q <sub>RR</sub>			108		nC
Reverse Recovery Energy	E <sub>REC</sub>			4.5		μJ
Peak Reverse Recovery Current	I <sub>RRM</sub>			11		A
Charge time	T <sub>a</sub>			11		ns
Discharge time	T <sub>b</sub>			8.5		ns

Product parametric performance is indicated in the Electrical Characteristics for the listed test conditions, unless otherwise noted. Product performance may not be indicated by the Electrical Characteristics if operated under different conditions.

TYPICAL CHARACTERISTICS

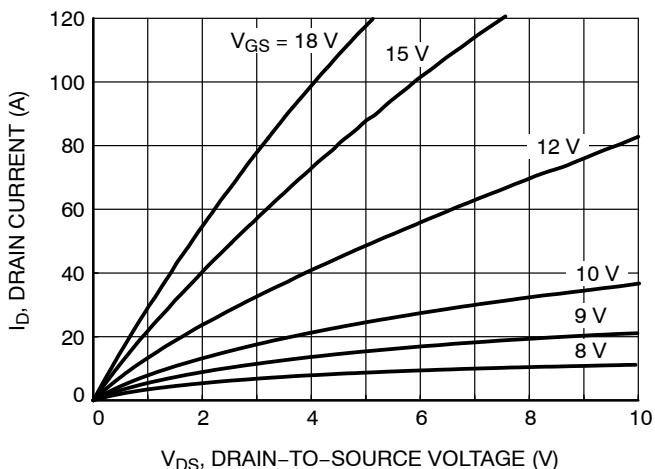

Figure 1. On-Region Characteristics

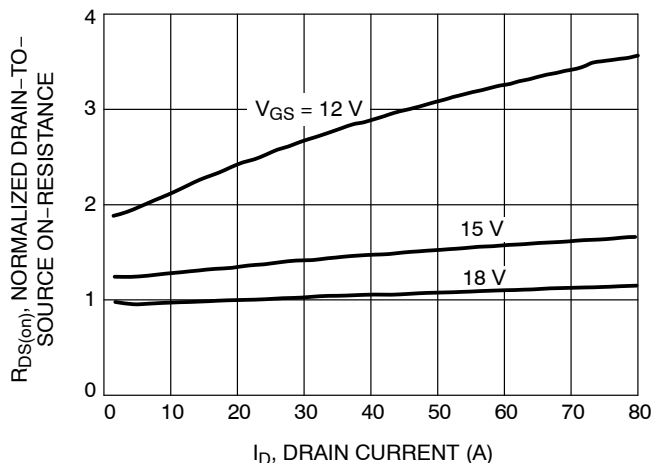

Figure 2. Normalized On-Resistance vs. Drain Current and Gate Voltage

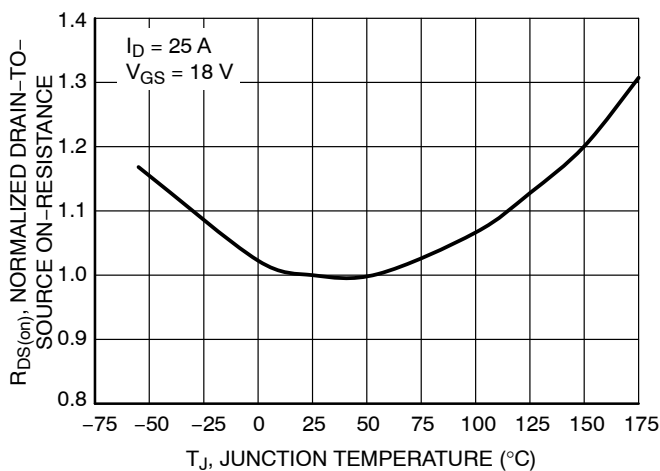

Figure 3. On-Resistance Variation with Temperature

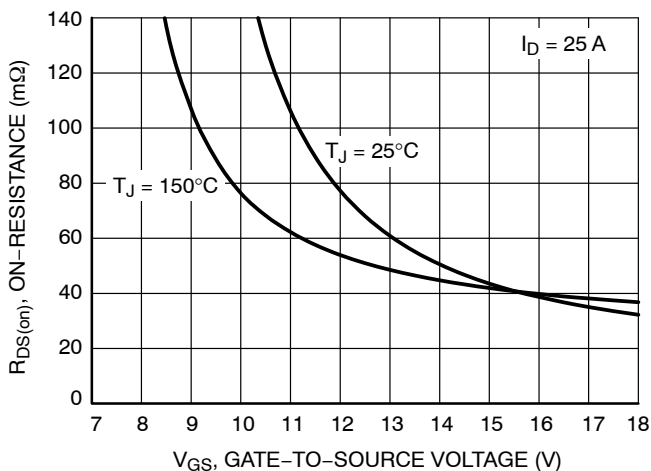

Figure 4. On-Resistance vs. Gate-to-Source Voltage

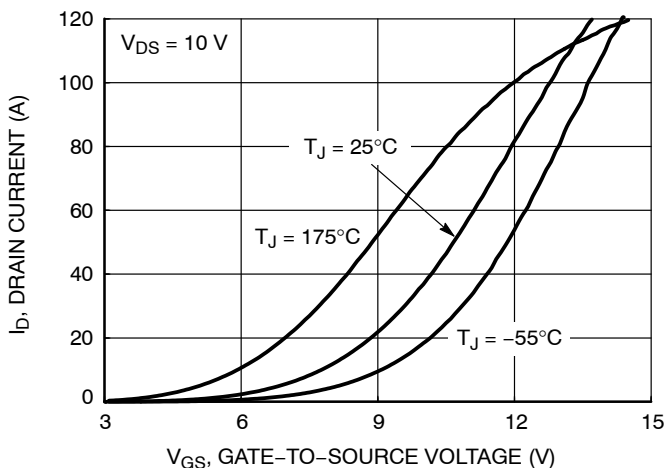

Figure 5. Transfer Characteristics

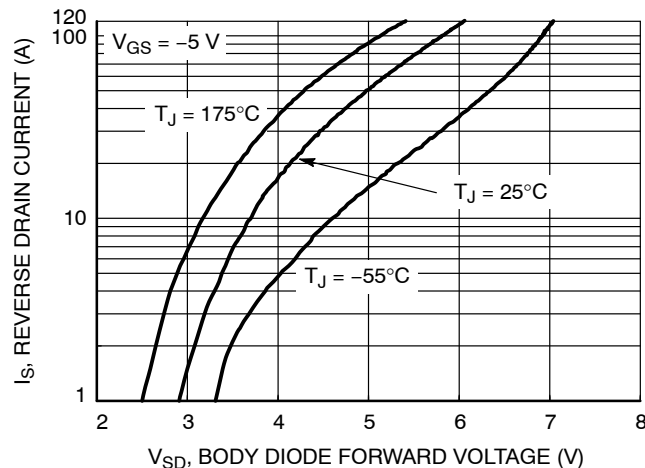

Figure 6. Diode Forward Voltage vs. Current

TYPICAL CHARACTERISTICS

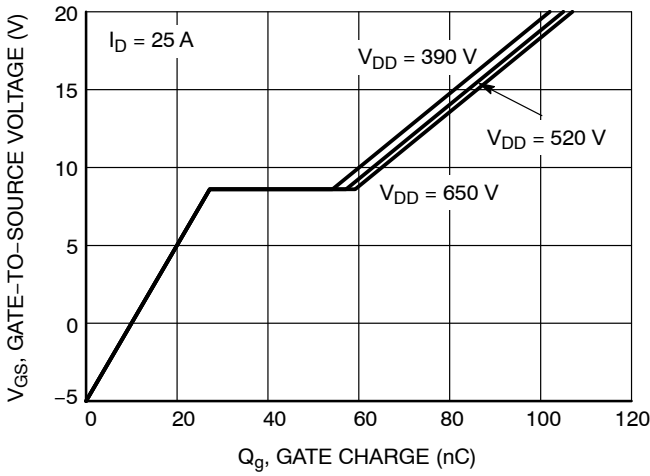

Figure 7. Gate-to-Source Voltage vs. Total Charge

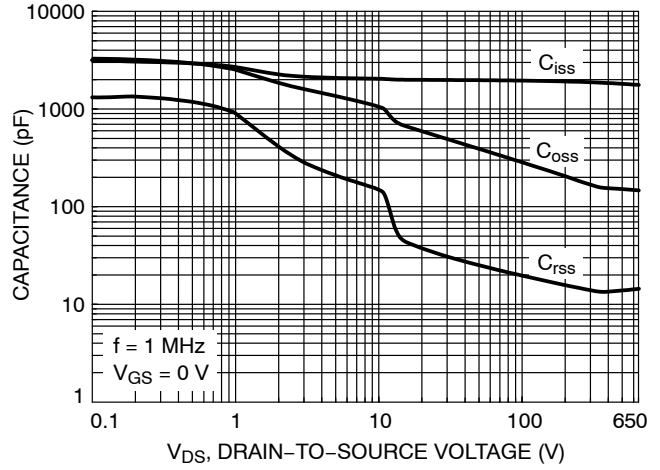

Figure 8. Capacitance vs. Drain-to-Source Voltage

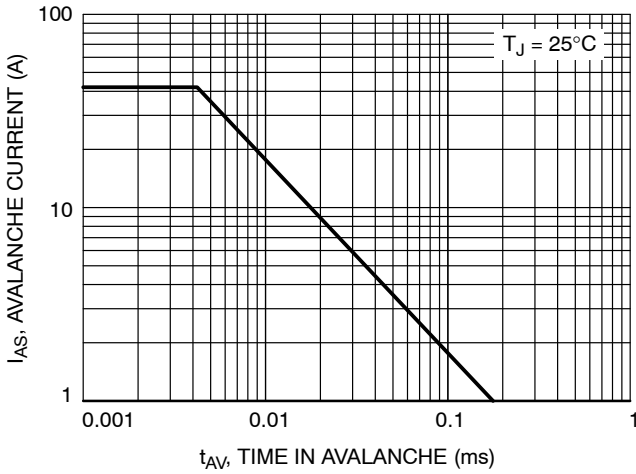

Figure 9. Unclamped Inductive Switching Capability

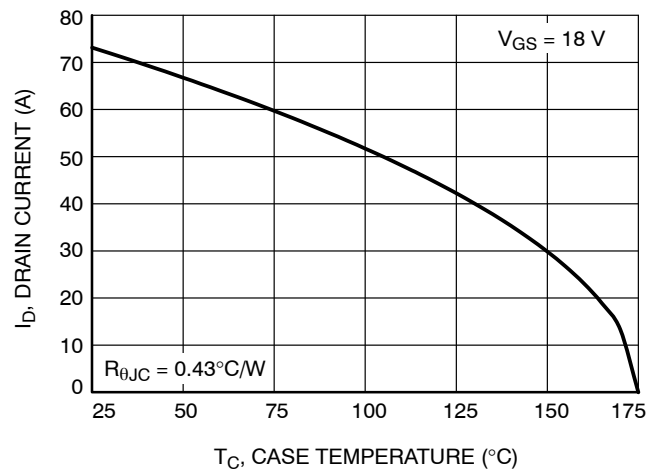

Figure 10. Maximum Continuous Drain Current vs. Case Temperature

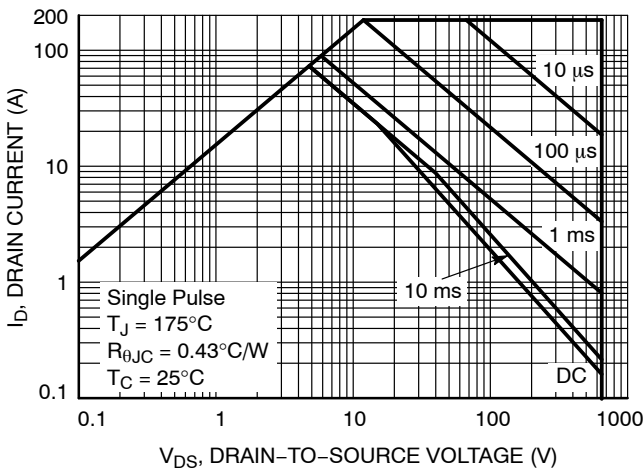

Figure 11. Safe Operating Area

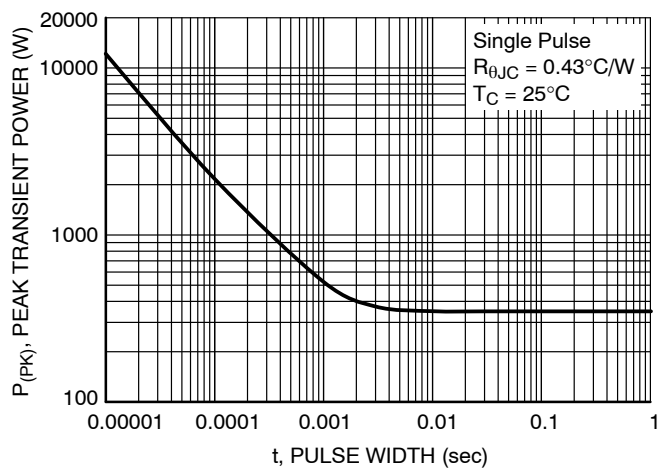
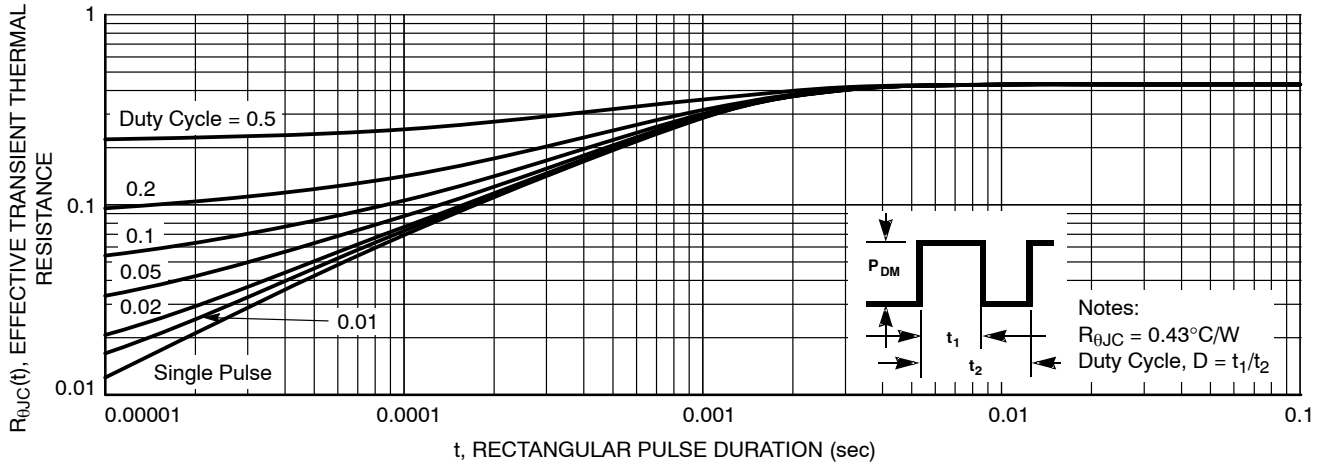

Figure 12. Single Pulse Maximum Power Dissipation

# NTBL045N065SC1

## TYPICAL CHARACTERISTICS



**Figure 13. Transient Thermal Impedance**

### DEVICE ORDERING INFORMATION

Device	Package	Shipping <sup>†</sup>
NTBL045N065SC1	H-PSOF8L	2000 / Tape & Reel

<sup>†</sup>For information on tape and reel specifications, including part orientation and tape sizes, please refer to our Tape and Reel Packaging Specifications Brochure, BRD8011/D.

# MECHANICAL CASE OUTLINE PACKAGE DIMENSIONS

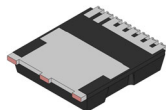

**H-PSOF8L 9.90x11.68, 1.20P**  
CASE 100DC  
ISSUE A

DATE 18 MAY 2023

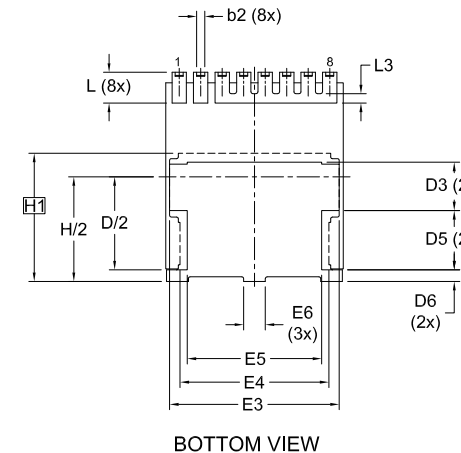
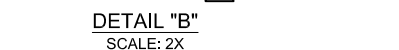
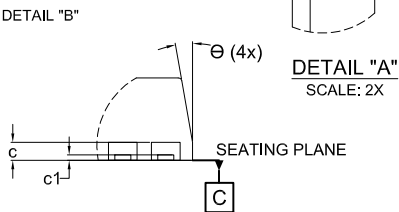
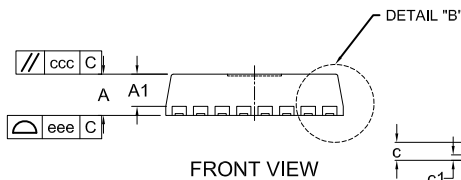
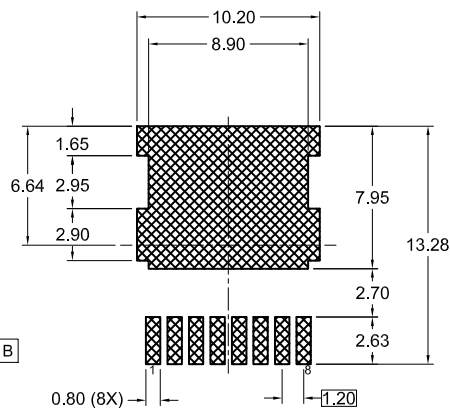
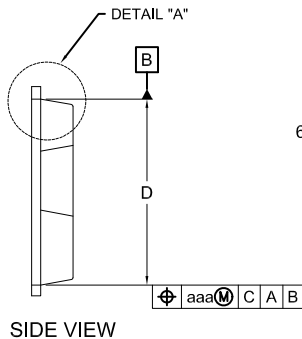
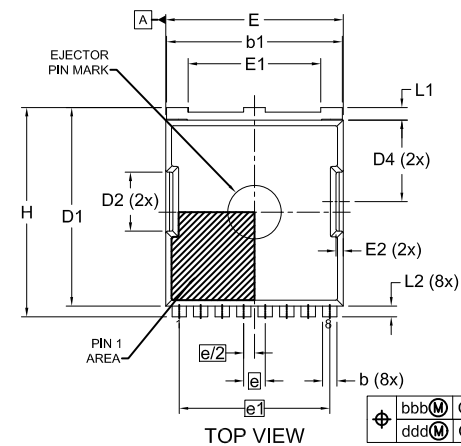

### GENERIC MARKING DIAGRAM\*

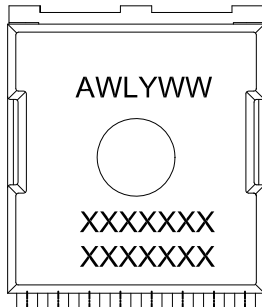

A = ASSY LOCATION  
WL = WAFER LOT CODE  
Y = YEAR CODE  
WW = WORK WEEK CODE  
XXXXXXXX = DEVICE CODE  
XXXXXXXX = DEVICE CODE

\*THIS INFORMATION IS GENERIC.  
PLEASE REFER TO DEVICE DATA SHEET FOR ACTUAL PART MARKING.

### NOTES:

1. PACKAGE STANDARD REFERENCE: JEDEC MO-299, ISSUE A.
2. DIMENSIONING AND TOLERANCING PER ASME Y14.5M, 2009.
3. CONTROLLING DIMENSION: MILLIMETERS.
4. COPLANARITY APPLIES TO THE EXPOSED WELL AS THE TERMINALS.
5. DIMENSIONS D1 AND E1 DO NOT INCLUDE MOLD FLASH, PROTRUSIONS, OR GATE BURRS.
6. SEATING PLANE IS DEFINED BY THE TERMINALS. "A1" IS DEFINED AS THE DISTANCE FROM THE SEATING PLANE TO THE LOWEST POINT ON THE PACKAGE BODY.

DIM	MILLIMETERS		
	MIN.	NOM.	MAX.
A	2.20	2.30	2.40
A1	1.70	1.80	1.90
b	0.70	0.80	0.90
b1	9.70	9.80	9.90
b2	0.35	0.45	0.55
c	0.40	0.50	0.60
c1	0.10	---	---
D	10.28	10.38	10.48
D/2	5.09	5.19	5.29
D1	10.98	11.08	11.18
D2	3.20	3.30	3.40
D3	2.60	2.70	2.80
D4	4.45	4.55	4.65
D5	3.20	3.30	3.40
D6	0.55	0.65	0.75
E	9.80	9.90	10.00
E1	7.30	7.40	7.50
E2	0.30	0.40	0.50
E3	9.36	9.46	9.56

DIM	MILLIMETERS		
	MIN.	NOM.	MAX.
E4	8.20	8.30	8.40
E5	7.40	7.50	7.60
E6	1.10	1.20	1.30
e	1.20 BSC		
e/2	0.60 BSC		
e1	8.40 BSC		
H	11.58	11.68	11.78
H/2	5.74	5.84	5.94
H1	7.15 BSC		
L	1.63	1.73	1.83
L1	0.60	0.70	0.80
L2	0.50	0.60	0.70
L3	0.70	0.80	0.90
theta	0°	---	12°
aaa	0.20		
bbb	0.25		
ccc	0.20		
ddd	0.20		
eee	0.10		

<b>DOCUMENT NUMBER:</b>	<b>98AON80466G</b>	Electronic versions are uncontrolled except when accessed directly from the Document Repository. Printed versions are uncontrolled except when stamped "CONTROLLED COPY" in red.
<b>DESCRIPTION:</b>	<b>H-PSOF8L 9.90x11.68, 1.20P</b>	<b>PAGE 1 OF 1</b>

onsemi and onsemi are trademarks of Semiconductor Components Industries, LLC dba onsemi or its subsidiaries in the United States and/or other countries. onsemi reserves the right to make changes without further notice to any products herein. onsemi makes no warranty, representation or guarantee regarding the suitability of its products for any particular purpose, nor does onsemi assume any liability arising out of the application or use of any product or circuit, and specifically disclaims any and all liability, including without limitation special, consequential or incidental damages. onsemi does not convey any license under its patent rights nor the rights of others.

**onsemi**, **Onsemi**, and other names, marks, and brands are registered and/or common law trademarks of Semiconductor Components Industries, LLC dba "**onsemi**" or its affiliates and/or subsidiaries in the United States and/or other countries. **onsemi** owns the rights to a number of patents, trademarks, copyrights, trade secrets, and other intellectual property. A listing of **onsemi**'s product/patent coverage may be accessed at [www.onsemi.com/site/pdf/Patent-Marking.pdf](http://www.onsemi.com/site/pdf/Patent-Marking.pdf). **onsemi** reserves the right to make changes at any time to any products or information herein, without notice. The information herein is provided "as-is" and **onsemi** makes no warranty, representation or guarantee regarding the accuracy of the information, product features, availability, functionality, or suitability of its products for any particular purpose, nor does **onsemi** assume any liability arising out of the application or use of any product or circuit, and specifically disclaims any and all liability, including without limitation special, consequential or incidental damages. Buyer is responsible for its products and applications using **onsemi** products, including compliance with all laws, regulations and safety requirements or standards, regardless of any support or applications information provided by **onsemi**. "Typical" parameters which may be provided in **onsemi** data sheets and/or specifications can and do vary in different applications and actual performance may vary over time. All operating parameters, including "Typicals" must be validated for each customer application by customer's technical experts. **onsemi** does not convey any license under any of its intellectual property rights nor the rights of others. **onsemi** products are not designed, intended, or authorized for use as a critical component in life support systems or any FDA Class 3 medical devices or medical devices with a same or similar classification in a foreign jurisdiction or any devices intended for implantation in the human body. Should Buyer purchase or use **onsemi** products for any such unintended or unauthorized application, Buyer shall indemnify and hold **onsemi** and its officers, employees, subsidiaries, affiliates, and distributors harmless against all claims, costs, damages, and expenses, and reasonable attorney fees arising out of, directly or indirectly, any claim of personal injury or death associated with such unintended or unauthorized use, even if such claim alleges that **onsemi** was negligent regarding the design or manufacture of the part. **onsemi** is an Equal Opportunity/Affirmative Action Employer. This literature is subject to all applicable copyright laws and is not for resale in any manner.

## ADDITIONAL INFORMATION

### TECHNICAL PUBLICATIONS:

Technical Library: [www.onsemi.com/design/resources/technical-documentation](http://www.onsemi.com/design/resources/technical-documentation)  
onsemi Website: [www.onsemi.com](http://www.onsemi.com)

### ONLINE SUPPORT: [www.onsemi.com/support](http://www.onsemi.com/support)

For additional information, please contact your local Sales Representative at [www.onsemi.com/support/sales](http://www.onsemi.com/support/sales)