



STM3210E-EVAL demonstration software

Introduction

This user manual describes the demonstration firmware running on the STM3210E-EVAL evaluation board, which can be used to evaluate the capabilities of the High-density STM32F103ZE(T6) microcontroller and on-board peripherals.

The STM3210E-EVAL board is delivered with the demonstration and the DFU (device firmware upgrade) programmed in the internal Flash memory, and all the files needed by the demonstration are programmed in the NOR Flash memory. At each reset (board power-up, external reset, etc.) the demonstration is executed. To run the DFU, the Key push-button must be kept pressed at reset.

In case the STM3210E-EVAL board was not factory-programmed, the demonstration application was erased or the NOR Flash memory contents were modified, the DFU can be used to program those files. For more details, refer to [Section 2](#) and [Section 3](#).

This demonstration firmware, the USB library, and other such firmware are available for download from the STMicroelectronics website: www.st.com.

Contents

- 1 Functional description 7**
 - 1.1 Power control 8
 - 1.2 Clocking 8
 - 1.3 Reset control 8
 - 1.4 Debug JTAG interface 8
 - 1.5 Serial wire debugger interface 8
 - 1.6 Display devices 8
 - 1.6.1 LCD 8
 - 1.6.2 LED 8
 - 1.7 Interfaces 8
 - 1.7.1 RS232 8
 - 1.7.2 CAN 9
 - 1.7.3 USB 9
 - 1.8 Motor control 9
 - 1.9 IrDA 9
 - 1.10 Miscellaneous peripherals 9
 - 1.10.1 Joystick 9
 - 1.10.2 Push-buttons 9
 - 1.10.3 12-bit analog-to-digital converter (ADC) 9
 - 1.10.4 Audio 9
 - 1.10.5 Storage memories 10
 - 1.10.6 Temperature sensor 10
 - 1.10.7 STM3210E-EVAL board jumper configuration 10

- 2 Running the demonstration 11**
 - 2.1 Menu 11
 - 2.1.1 Demo startup 13
 - 2.1.2 Navigation 15
 - 2.2 Clock sources 16
 - 2.2.1 Clock control 16
 - 2.2.2 Clock failure 16
 - 2.3 STM32F103ZE(T6) resources 18
 - 2.3.1 Peripherals 18

2.3.2	Interrupts	19
2.3.3	External interrupts	20
2.3.4	Internal memory size	20
2.3.5	External memory size	20
2.4	Demo applications	21
2.4.1	Product presentation	21
2.4.2	Calendar	23
2.4.3	Animation submenu	28
2.4.4	Wave Player submenu	30
2.4.5	USB mass storage	34
2.4.6	Low-power modes	36
2.4.7	Smartcard	43
2.4.8	Thermometer	46
2.4.9	Help submenu	47
2.4.10	About submenu	49
3	Demonstration programming using the DFU	50
3.1	Programming the M29W128 NOR Flash memory	50
3.2	Demo programming	54
4	Revision history	58

List of tables

Table 1.	STM32F103ZE(T6) demo peripherals	18
Table 2.	STM32F103ZE(T6) demo interrupts	19
Table 3.	STM32F103ZE(T6) demo external interrupts	20
Table 4.	Document revision history	58

List of figures

Figure 1.	Evaluation board overview	7
Figure 2.	Structure of the demonstration menus	12
Figure 3.	Warning message	13
Figure 4.	ST Logo	13
Figure 5.	STM32 family	13
Figure 6.	Time and date configuration	14
Figure 7.	Main menu	14
Figure 8.	Corresponding submenus.	15
Figure 9.	Navigating in the demonstration menus	15
Figure 10.	Clock tree diagram	16
Figure 11.	No HSE clock detected.	17
Figure 12.	Standby mode entered	17
Figure 13.	Internal Flash memory organization	20
Figure 14.	NOR Flash memory organization	20
Figure 15.	Product presentation is ready to start	21
Figure 16.	First presentation slide	21
Figure 17.	Last presentation slide	22
Figure 18.	No loaded wave file	22
Figure 19.	End of slide show	23
Figure 20.	Setting the time and date	23
Figure 21.	Time Adjust submenu	24
Figure 22.	Time Show submenu	24
Figure 23.	Setting the Year	25
Figure 24.	Setting the Month	26
Figure 25.	Setting the day of the month.	26
Figure 26.	Exiting the Date Show submenu.	26
Figure 27.	Setting the alarm activation time.	27
Figure 28.	Alarm Show submenu.	27
Figure 29.	The time and date need setting	28
Figure 30.	Animation submenu	28
Figure 31.	STM32 Banner Animation.	29
Figure 32.	Exit submenu	29
Figure 33.	STM32 Display Speed	30
Figure 34.	Exit submenu	30
Figure 35.	Wave Player submenu	31
Figure 36.	Wave Player interface.	31
Figure 37.	Wave Player Playing submenu.	32
Figure 38.	Pause submenu	32
Figure 39.	Memory Error submenu	33
Figure 40.	I ² C Communication Error submenu	33
Figure 41.	Audio file Error submenu	34
Figure 42.	USB Mass Storage submenu	34
Figure 43.	USB Mass Storage submenu selected	35
Figure 44.	USB cable connected	35
Figure 45.	NAND Erase operation	36
Figure 46.	NAND Flash Erase operation completed	36
Figure 47.	Exiting the Stop mode.	37
Figure 48.	Stop mode entered	37

Figure 49.	MCU in the Stop mode	38
Figure 50.	RTC Alarm causes the MCU to exit the Stop mode	38
Figure 51.	Setting the Wakeup time	39
Figure 52.	RTC Alarm wakeup configured	39
Figure 53.	RTC Alarm wakeup	39
Figure 54.	Time and Date configuration prompt	40
Figure 55.	Entering the Standby mode	40
Figure 56.	MCU in Standby mode	41
Figure 57.	RTC Alarm causes the MCU to exit the Standby mode	41
Figure 58.	Setting the wakeup time	42
Figure 59.	RTC Alarm wakeup configured	42
Figure 60.	Time and Date configuration prompt	43
Figure 61.	Smartcard submenu - 1	43
Figure 62.	Smartcard submenu - 2	44
Figure 63.	Smartcard submenu - 3	44
Figure 64.	Smartcard ATR decoded	44
Figure 65.	Smartcard ATR	45
Figure 66.	Smartcard Error message	45
Figure 67.	Noncompatible smartcard error message	46
Figure 68.	Thermometer submenu selected	46
Figure 69.	Temperature display	47
Figure 70.	Temperature sensor error	47
Figure 71.	Help submenu	48
Figure 72.	Joystick buttons	48
Figure 73.	Second Help slide	48
Figure 74.	About submenu	49
Figure 75.	Programming the NOR Flash memory	51
Figure 76.	Selecting the STM3210E-EVAL_Demo_NORFlash_V1.0.dfu file	52
Figure 77.	Click Yes to continue	52
Figure 78.	NOR Flash memory programming	53
Figure 79.	Programming the demo	54
Figure 80.	Selecting the STM3210E-EVAL_Demo_V1.0.dfu file	55
Figure 81.	Click Yes to continue	55
Figure 82.	Internal Flash memory programming	56
Figure 83.	DFU mode left	57

1 Functional description

The STM32F103ZE(T6) microcontroller evaluation board provides a development and demonstration platform for STM32F103xx-based applications. It is designed to allow the user to try out the major functions of the STM32F103ZE(T6) microcontroller.

Figure 1 summarizes the main functional blocks of the evaluation board.

Figure 1. Evaluation board overview

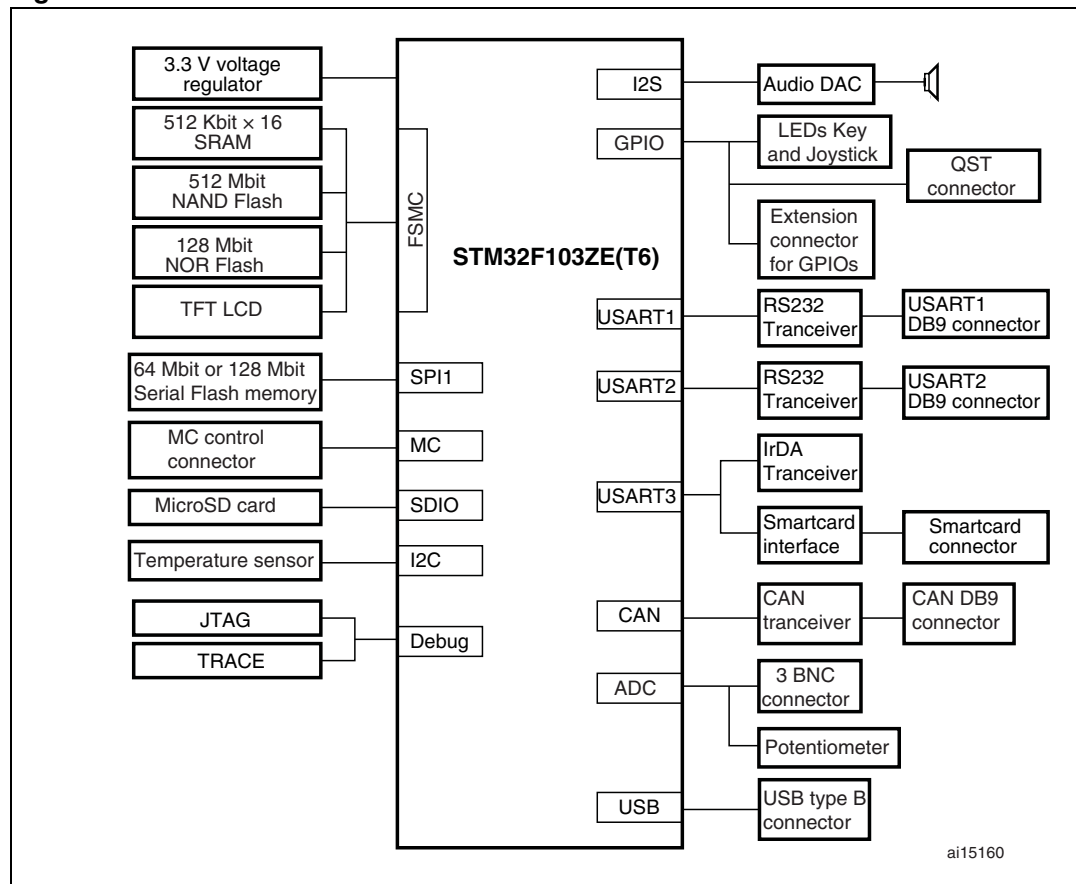

1.1 Power control

The evaluation board can be powered from an external 5 V supply or from the USB connector, all other required voltages are provided by on-board voltage regulators.

1.2 Clocking

Two clock sources are available on the STM3210E-EVAL evaluation board:

- 32 kHz crystal for embedded RTC
- 8 MHz crystal for STM32F103ZE

1.3 Reset control

The reset can be generated by hardware or software:

- Reset button: activates the RESET input when pressed
- JTAG reset

1.4 Debug JTAG interface

Software debug is done via the standard ARM[®] JTAG connection: 20-pin IDC (insulation displacement connector) for connection to the standard ARM host interface.

1.5 Serial wire debugger interface

The Serial Wire Debug Port (SWD-DP) provides a 2-pin (clock + data) interface to the AHP-AP port.

1.6 Display devices

1.6.1 LCD

A color LCD module is mounted on the STM3210E-EVAL board. It is interfaced through the embedded FSMC controller.

1.6.2 LED

Four general-purpose LEDs are available. They are used as a display.

1.7 Interfaces

1.7.1 RS232

The STM32F103ZE evaluation board (STM3210E-EVAL) provides two on-board RS-232 serial ports. Both RS232 ports are accessed via DB9 connectors.

1.7.2 CAN

The STM3210E-EVAL evaluation board supports CAN 2.0 A/CAN 2.0 B-compliant CAN bus communication based on a 3.3 V CAN transceiver. Both the high-speed mode and the slope-control mode are available. They are selected by setting a dedicated jumper.

1.7.3 USB

The STM3210E-EVAL evaluation board supports full-speed USB 2.0 communication thanks to its embedded USB peripheral.

1.8 Motor control

The STM3210E-EVAL evaluation board supports inductor motor control via a 34-pin connector that provides all required control and feedback signals to and from the motor power-driving board.

1.9 IrDA

The STM3210E-EVAL evaluation board supports IrDA communication. The interface is mounted on USART3.

1.10 Miscellaneous peripherals

1.10.1 Joystick

Four-direction joystick with a selection key.

1.10.2 Push-buttons

The following push-buttons are provided:

- Key: user push-button
- Tamper: user push-button
- Wakeup: push-button used to wake up the processor from a low-power mode

1.10.3 12-bit analog-to-digital converter (ADC)

Varistor: ADC channel3 connected to an on-board variable resistor. The variable resistor provides a voltage in the range of 0 V to 3.3 V.

Moreover, three BNC connectors are available for analog input.

1.10.4 Audio

The STM3210E-EVAL evaluation board implements a dedicated audio DAC with an I²S interface. For the audio output, a speaker and an audio Jack are available on the board and connected to the DAC.

1.10.5 Storage memories

The STM3210E-EVAL evaluation board has five different storage memories: an SPI Flash memory of 8 Mbyte connected to the SPI1 peripheral, an MSD (mass storage device) of 128 Mbyte connected to the SDIO peripheral, a 1 Mbyte SRAM, a 64 Mbyte NAND Flash memory and a 16 Mbyte NOR Flash memory. The SRAM, the NAND Flash memory and the NOR Flash memory are connected together to the FSMC interface.

1.10.6 Temperature sensor

The STM3210E-EVAL evaluation board includes an I²C temperature sensor connected to the I2C1 peripheral.

1.10.7 STM3210E-EVAL board jumper configuration

To be able to run the STM3210E-EVAL demo correctly, configure the following STM3210E-EVAL board jumpers as follows:

- I²S MCLK JP18: position 2<->3
- Smartcard JP15: fitted
- Smartcard JP16: fitted
- SD Card JP17: fitted
- SD Card JP20: open
- USB JP14: position 2<->3
- NAND JP7: position 1<->2
- JP4: position 1<->2

2 Running the demonstration

2.1 Menu

Figure 2 shows the menu system of the STM32F103ZE demonstration. The main menu is shown on the left-hand side. The UP, DOWN, RIGHT and LEFT joystick directions allow the user to navigate between items in the main menu and the submenus. To enter a submenu, press the SEL push-button (SEL push-button is the switch closure that occurs when the joystick button is pushed). To exit a submenu select the **Return** menu and press SEL.

Figure 2. Structure of the demonstration menus

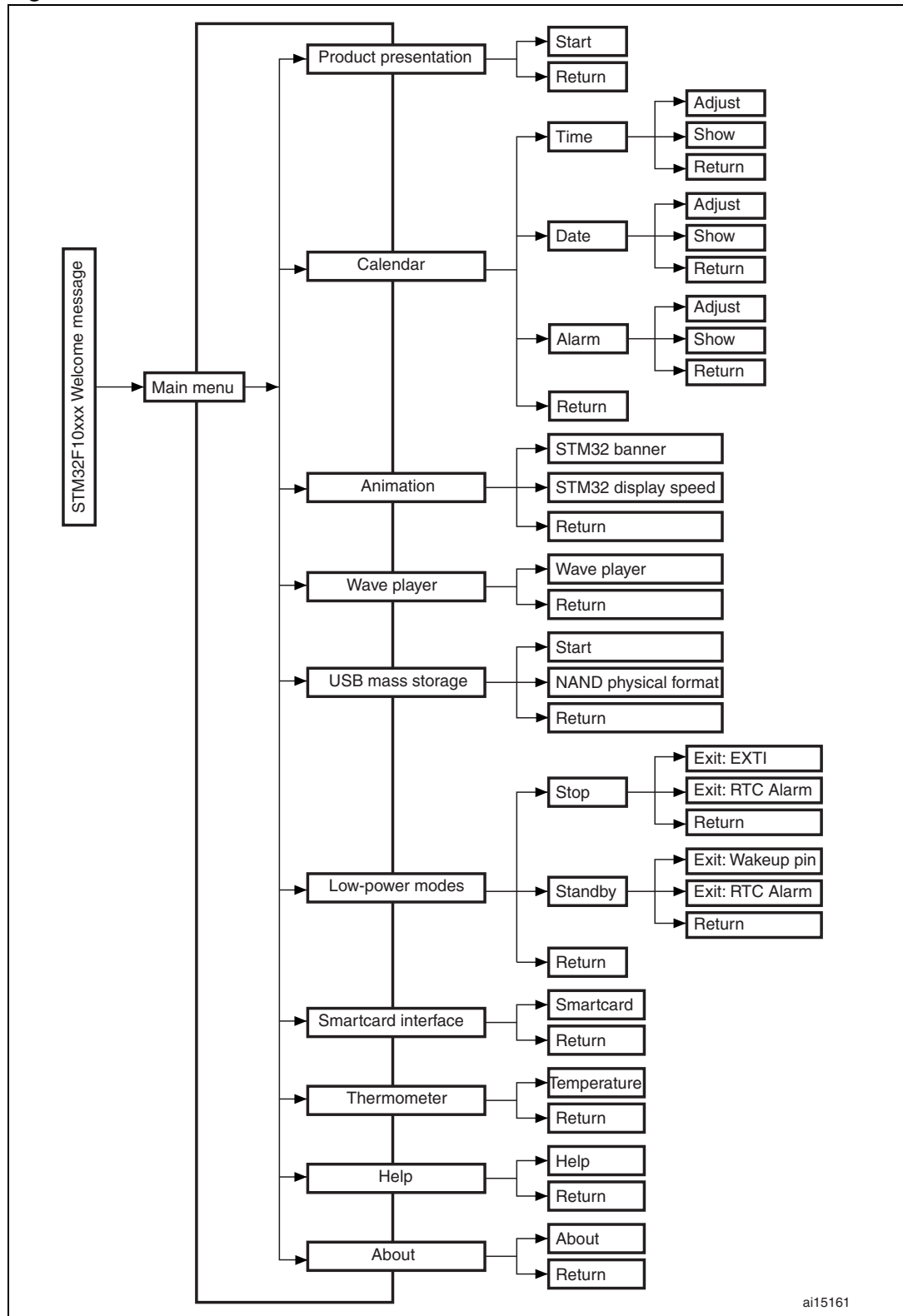

ai15161

2.1.1 Demo startup

After a board reset, at demo startup, the icons and bitmap files are checked in the NOR Flash memory. All the icons have to be correctly programmed in the NOR Flash memory for the demo to start, so if an icon is missing, the demo will not start and the message shown in *Figure 3* is displayed on the LCD screen.

Figure 3. Warning message

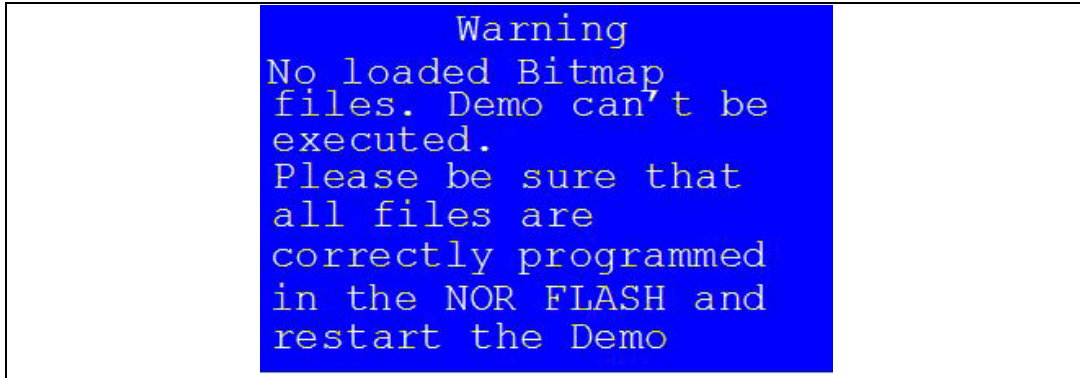

However, if the icons are correctly loaded into the NOR Flash memory, the Welcome screen is displayed and the ST Logo appears on the LCD (see *Figure 4*).

Figure 4. ST Logo



Then, after 1 second, the following STM32 slide is displayed on the LCD screen as shown in *Figure 5*.

Figure 5. STM32 family



When the board is powered up for the first time and no power supply on V_{BAT} is detected (Battery), the user is prompted to set the time, year, month and day. The user may choose to ignore it by pressing any key except for the SEL push-button to abort the configuration

sequence. To set the time and date, the user should press SEL and follow the setting sequence.

The message shown in *Figure 6* appears on the LCD screen.

Figure 6. Time and date configuration

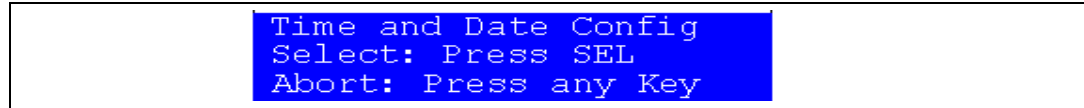

- Note: 1 If the user chooses to configure the time and date, the **Time Adjust** and **Date Adjust** menus are displayed. Otherwise the main menu is displayed and the user can set the time parameters in the **Calendar** menu. To set the time/date use the joystick up/down and SEL push-buttons.
- 2 If the time configuration has already been done, then the number of elapsed days (higher than 1 day) from the last time the demo board was powered up appears on the LCD screen. It is soon followed by the current date.

Once the time/date have been set, the main menu appears. The main menu is displayed in the form of a set of icons. It presents all the submenus in the same screen. The user can navigate using the UP, DOWN, RIGHT and LEFT joystick directions to select the desired submenu. To enter the desired submenu, the user has to press the SEL joystick push-button, and the new submenu corresponding to the selected icon is displayed.

Figure 7. Main menu

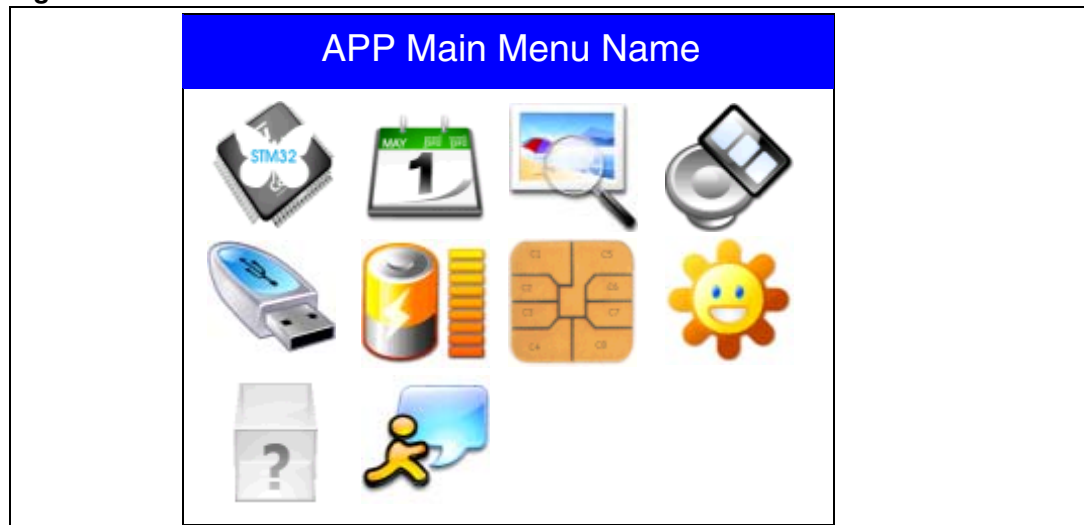

1. The icons shown in *Figure 7* are taken from http://commons.wikimedia.org/wiki/Crystal_Clear.

Once a submenu has been selected, the name of the application is listed at the top of the display and all the corresponding submenus are listed below as shown in *Figure 8*.

Figure 8. Corresponding submenus

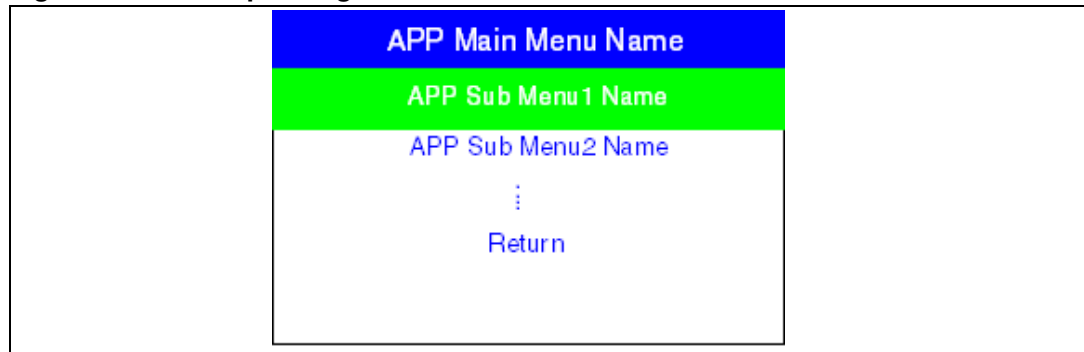

2.1.2 Navigation

The demonstration menu is based on circular navigation, submenu selection, item selection and back capability as described in [Figure 9](#).

Figure 9. Navigating in the demonstration menus

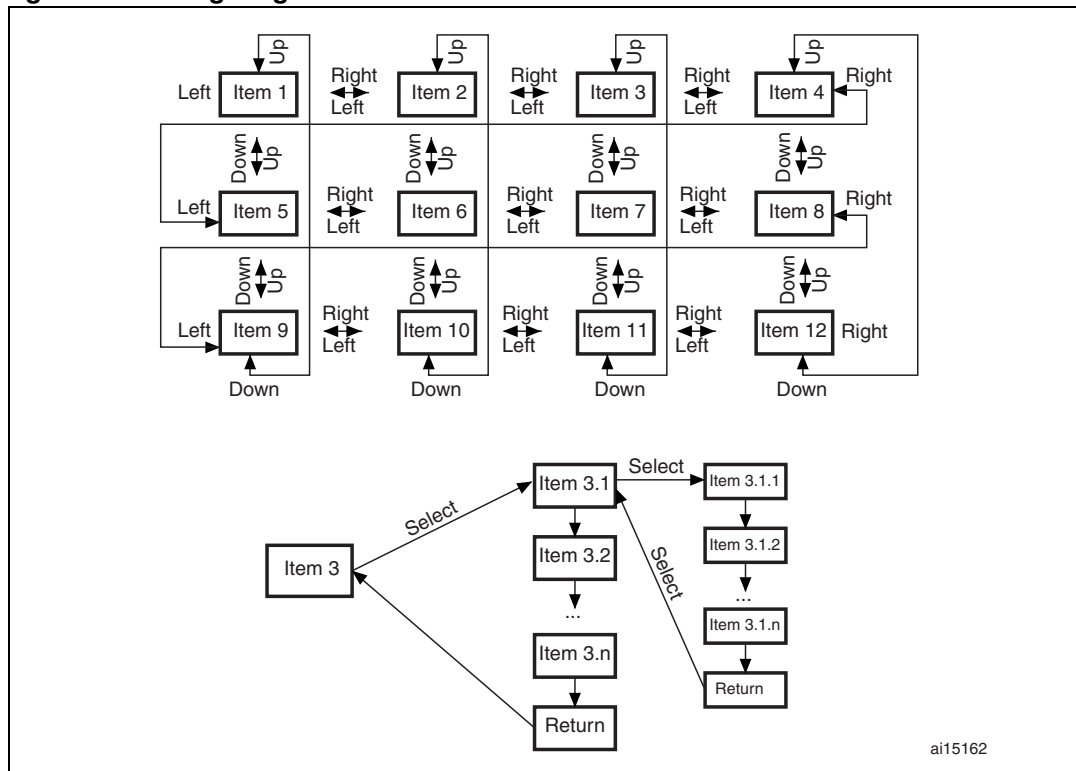

The user navigates using the joystick push-buttons located on the evaluation board: RIGHT, LEFT, SEL, UP and DOWN.

- the UP, DOWN, RIGHT and LEFT push-buttons are used to perform circular navigation in the main menu and the current menu items
- the SEL push-button selects the current item
- the UP and DOWN push-buttons are used for vertical navigation in the submenus
- to return to the upper menu, go to the Return line and press SEL

2.2 Clock sources

2.2.1 Clock control

The STM32F103ZE's internal clocks are derived from the HSE (clocked by the external 8 MHz crystal).

In this demo application, the different system clocks are configured as follows:

- System clock is set to 72 MHz: the PLL is used as the system clock source: 72 MHz (two wait states, Flash memory prefetch buffer enabled).
- HCLK frequency is set to 72 MHz
- Timer clock (TIMCLK) is set to 72 MHz
- PCLK1 is set to 36 MHz
- PCLK2 is set to 72 MHz
- USB clock (USBCLK) is set to 48 MHz (internal clock: PLLCLK / 1.5)

Only the RTC is clocked by a 32 kHz external oscillator.

Figure 10. illustrates the clock tree organization for this demo.

Figure 10. Clock tree diagram

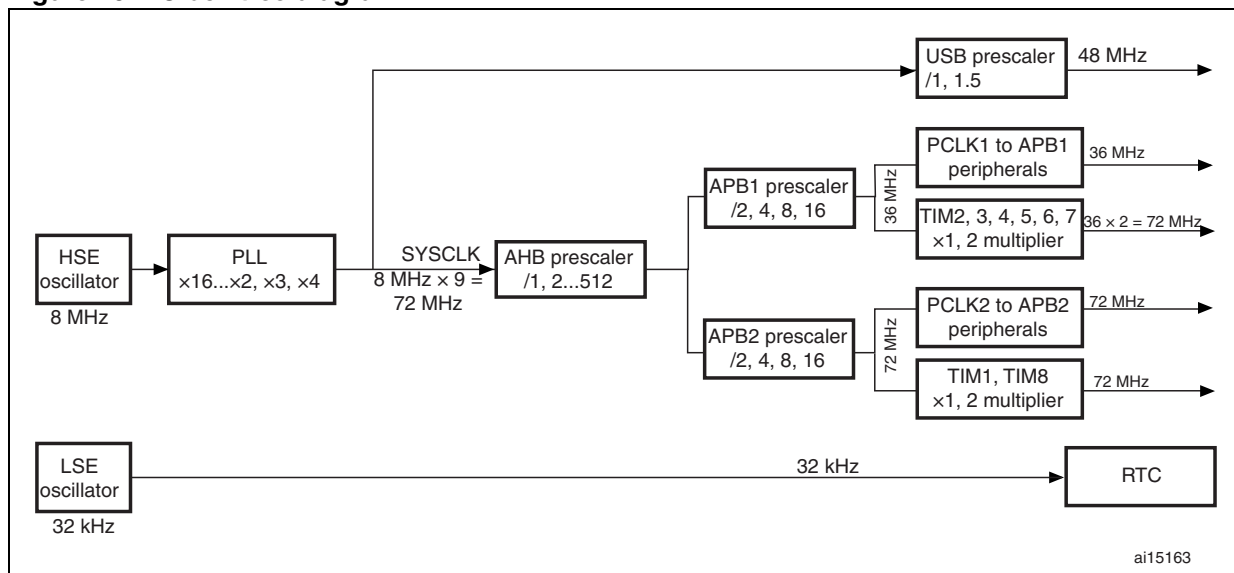

2.2.2 Clock failure

At any demo level, if no clock is present on OSC_IN (broken or disconnected crystal), the message shown in Figure 11 is displayed on the LCD screen.

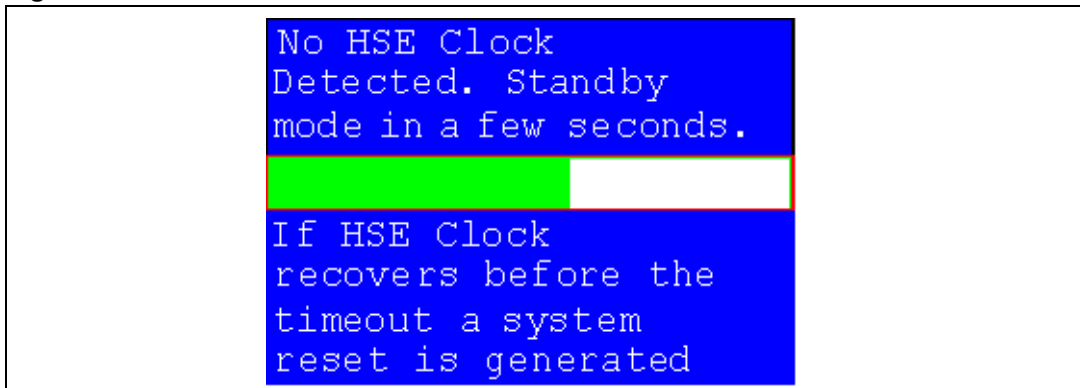
Figure 11. No HSE clock detected

If the 8 MHz Crystal is not reconnected in the next few seconds, the MCU enters the Standby mode. If the 8 MHz crystal is reconnected within a few seconds, a system reset is generated.

Note: The clock security system (CSS) feeds the MCU with the HSI OSC used as an emergency clock if no clock is detected.

When a timeout occurs, the MCU enters the Standby mode and the message shown in [Figure 12](#) is displayed on the LCD screen.

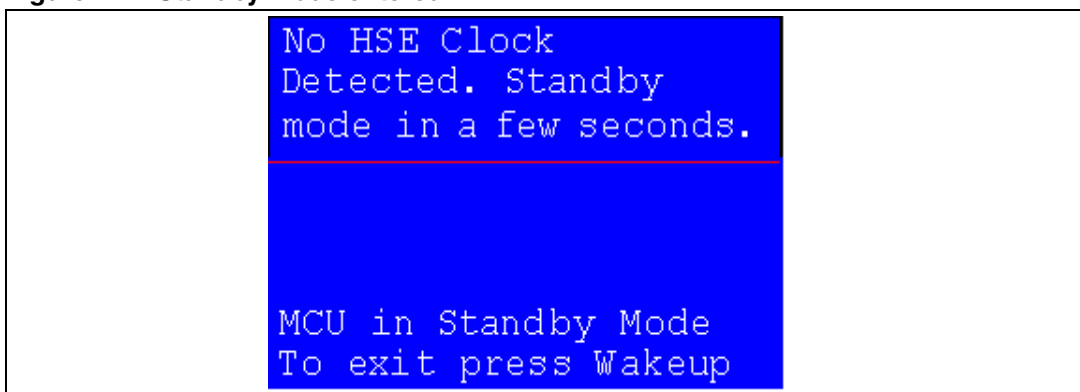
Figure 12. Standby mode entered

1. The demo will not restart as long as the 8 MHz crystal is not present.
2. Connecting the 8 MHz crystal after reset may not restart the demo correctly. The crystal must be connected before starting the demo.

2.3 STM32F103ZE(T6) resources

2.3.1 Peripherals

All used peripherals are described in [Table 1](#).

Table 1. STM32F103ZE(T6) demo peripherals

Used peripherals	Application
I2C1	Temperature sensor
BKP	Calendar + Demo kernel
EXTI	Menu navigation + joystick + Push Button + low-power modes
GPIO	All applications + LEDs
NVIC	All applications using interrupts
PWR	Low-power modes
RCC	All applications + Demo kernel
RTC	Calendar
SPI1	SPI Flash
SysTick	Generate 10 ms time base
TIM1	LED toggling
FSMC	Color LCD + NAND Flash + NOR Flash
SDIO	MSD
SPI2 (I2S)	Audio codec

2.3.2 Interrupts

Table 2 shows all the enabled interrupts.

Table 2. STM32F103ZE(T6) demo interrupts

Interrupts	Priority	Used for
SysTick	Preemption: 0 SubPriority: 0	System timing
RTC	Preemption: 0 SubPriority: 0	Calendar, date update
NMI	Preemption(fixed): -2	CSS interrupt
EXTI3	Preemption: 2 SubPriority: 1	Menu navigation
EXTI9_5	Preemption: 2 SubPriority: 1	Menu navigation
EXTI15_10	Preemption: 2 SubPriority: 0	Menu navigation
USB_LP_CAN_RX0	Preemption: 1 SubPriority: 0	USB Mass Storage
USB_HP_CAN_TX	Preemption: 0 SubPriority: 1	USB Mass Storage
TIM1_UP	Preemption: 1 SubPriority: 3	LED toggling
RTCAlarm	Preemption: 1 SubPriority: 1	Alarm generation
SPI2	Preemption: 0 SubPriority: 0	Audio data transfer

2.3.3 External interrupts

Table 3. STM32F103ZE(T6(demo external interrupts

External interrupts	Used for
EXTI line3	Joystick DOWN (interrupt mode, falling edge)
EXTI line15	Joystick UP (interrupt mode, falling edge)
EXTI line7	Joystick SEL (interrupt mode, falling edge)
EXTI line8	User Button (interrupt mode, falling edge)
EXTI line17	RTC Alarm (interrupt mode, rising edge)

2.3.4 Internal memory size

Figure 13. Internal Flash memory organization

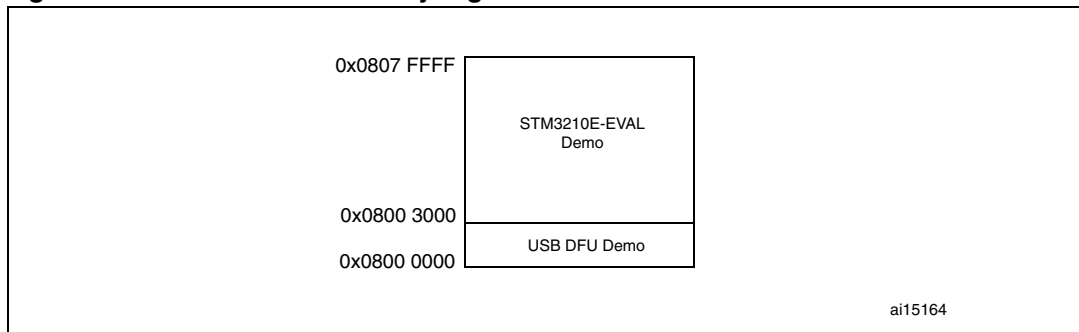

2.3.5 External memory size

Figure 14. NOR Flash memory organization

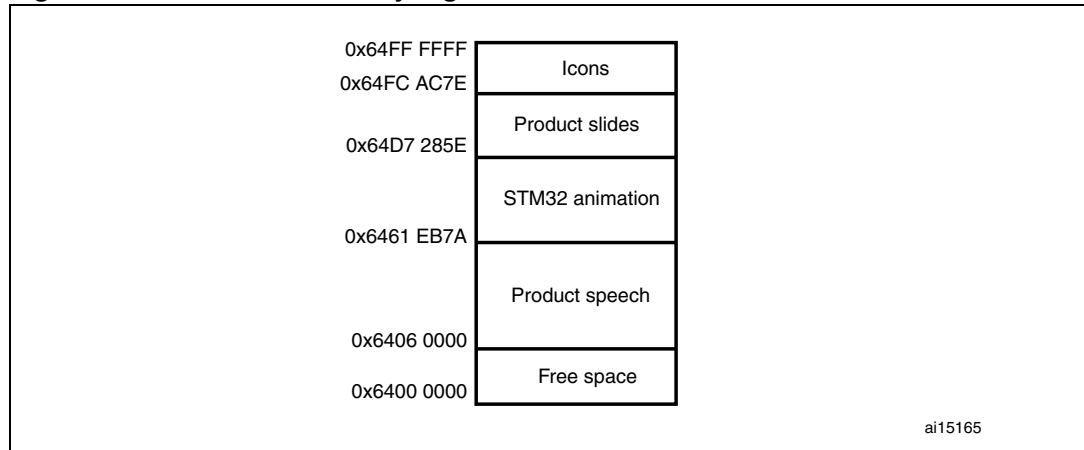

2.4 Demo applications

The following section provides a detailed description of each part of the demonstration.

- Note:
- 1 In the demonstration, the core runs at $HCLK = 72\text{ MHz}$.
 - 2 Four LEDs: LD1, LD2, LD3 and LD4 flash throughout the demonstration at a frequency depending on the core clock.

2.4.1 Product presentation

This part of the demo is dedicated to the listing of all the embedded STM32F103ZE(T6) peripherals and features. This presentation of the microcontroller is made with a set of slides accompanied by a speech. Each slide is associated with a dedicated speech. When the user starts the product presentation, the first slide appears and the corresponding speech starts. Once the speech is finished, the second slide is displayed accompanied by its speech and so on until the last slide.

When the **Product presentation** menu is selected, the message shown in [Figure 15](#) is displayed on the LCD screen.

Figure 15. Product presentation is ready to start

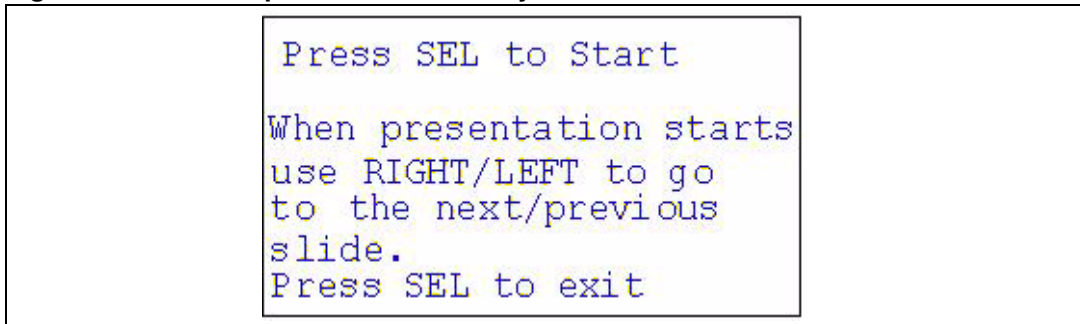

Product presentation slides

The set of slides is composed of 14 slides where all features and advantages of the STM32F103ZE(T6) are listed. [Figure 16](#) and [Figure 17](#) show the first and last slides, respectively.

Figure 16. First presentation slide



Figure 17. Last presentation slide



Product presentation speech

The High-density STM32F103xx microcontroller has two embedded SPI peripherals that can be used in I²S mode for audio communication. An external audio codec is implemented on the evaluation board in order to allow speech audio files to be played through the embedded speaker or headphone.

The properties of the product presentation speech wave file are the following:

- Playing time: 6 min 16s
- File size: 6 024 058 bytes
- Format tag: PCM
- Channels: Mono
- Sample rate: 8 kHz
- Bits per sample: 16 bits

Note: If the wave file of the promotion presentation speech is not loaded in the dedicated memory, the message shown in [Figure 18](#) is displayed on the LCD screen.

Figure 18. No loaded wave file

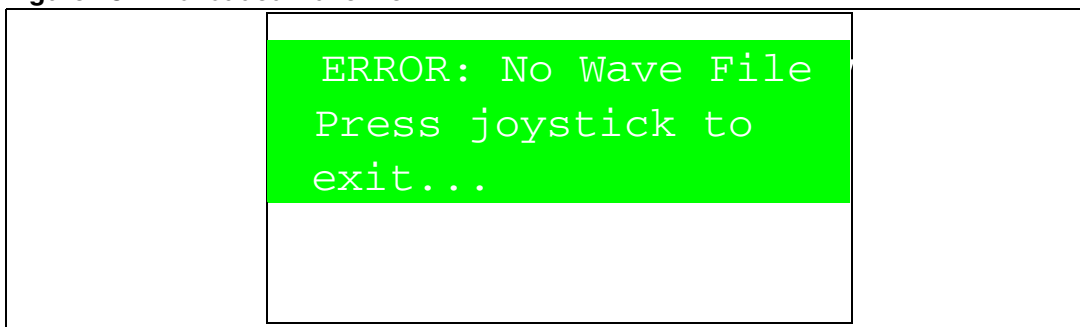

To stop the product presentation slide show and speech, push the SEL push-button. The message shown in [Figure 19](#) is displayed.

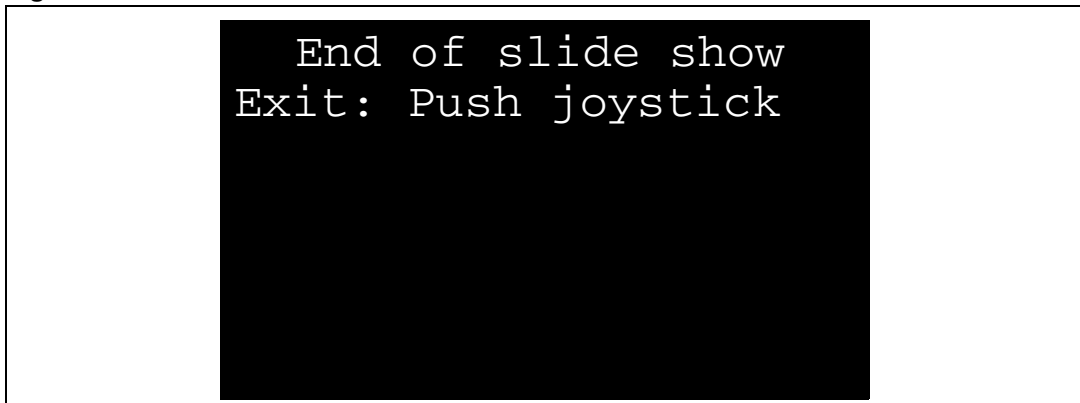
Figure 19. End of slide show

At the end of the product presentation or if the presentation was stopped, simply press any joystick key to exit and return to the **Product Presentation** submenu.

2.4.2 Calendar

The STM32F103ZE(T6) features a real-time clock (RTC) that provides a set of continuously running counters. These can be used, with suitable software, to implement a clock-calendar function. The counter values can be written to set the current time of the system.

This submenu is used to configure the time, date and alarm. The date, time and alarm settings are not lost when the board is powered off owing to the battery connected to the V_{BAT} pin. The V_{BAT} pin supplies power to the RTC unit, allowing the RTC to operate even when the main digital supply (V_{DD}) is turned off.

Note: To be able to use the battery to back up the RTC, the JP1 jumper must be in the position 1-2 in the STM3210E-EVAL board.

In any submenu, if the time and date parameters have not yet been configured, the message shown in [Figure 20](#) is displayed on the LCD screen.

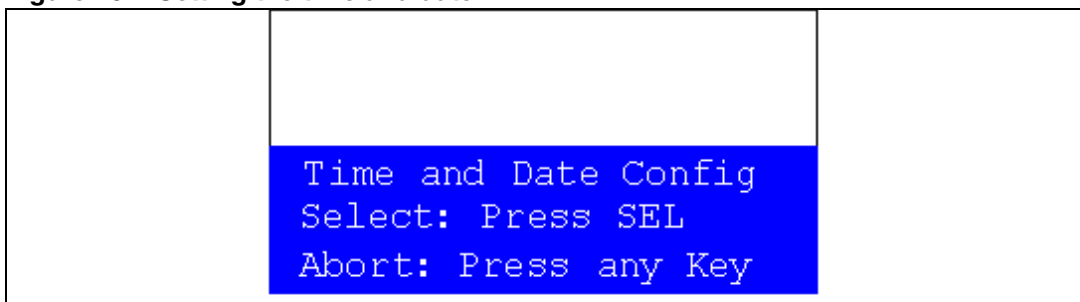
Figure 20. Setting the time and date

The user has the choice to set or not the time, year, month and day. Press any key (except for SEL) to ignore the prompt and abort the configuration sequence. Press on SEL and follow the setting sequence to set the time and date.

Time submenu

This submenu is divided into two items that allow the user to display or set the current time.

- **Time Adjust:** After the evaluation board is powered up, the user has to select this submenu to change the default time (00:00:00) to the current time. Once “Time Adjust” has been selected, the first digit of the hour field can be changed. Pressing the “UP” button will display the current value plus one. Pressing the “DOWN” button will display the previous digit value. After setting the digit value, press “SEL”, the cursor automatically jumps to the next digit. When all the time digits have been set, the “Time” submenu appears. Some digit values are limited to a range of values depending on the field (hour, minute or seconds). The following message (with the default time or the current time) is displayed on the LCD when this submenu is selected.

Figure 21. Time Adjust submenu

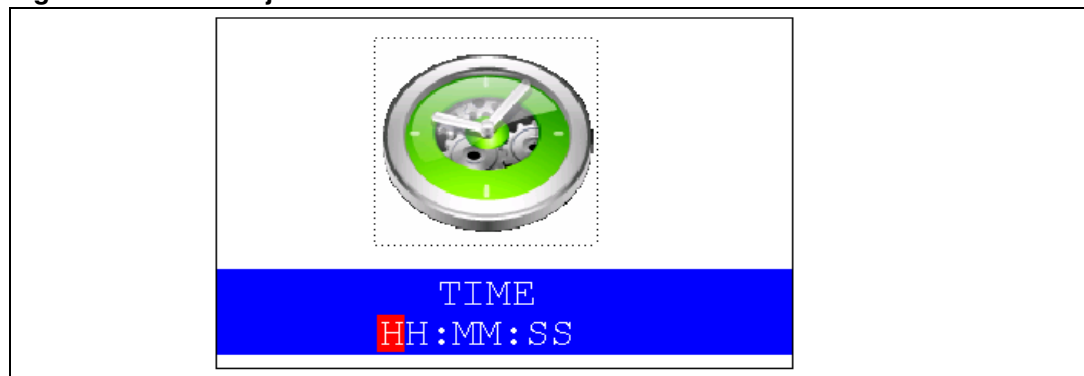

- **Time Show:** this item displays the current time. If time and date have not been configured before, a message is displayed, that gives the choice to set the time and date or, to exit to the upper submenu. When this submenu is selected, the message shown in [Figure 22](#) appears on the LCD. In the example, the time has not been set yet.

Figure 22. Time Show submenu

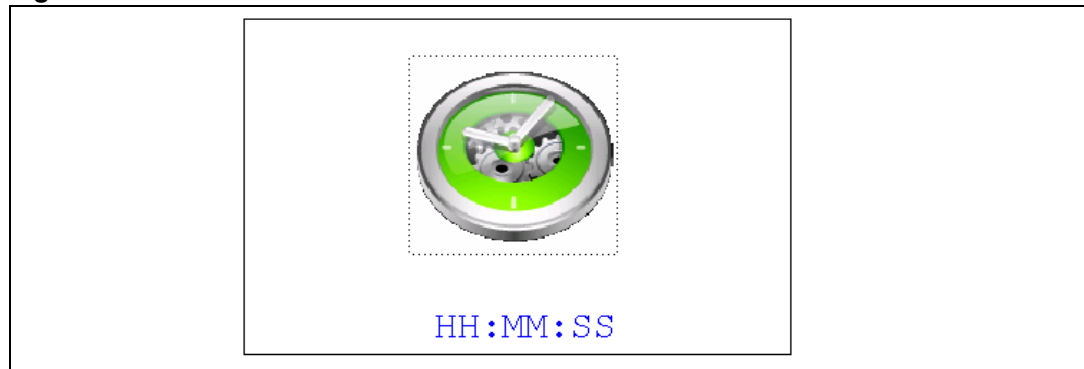

To exit the **Time Show** submenu press the SEL push-button. To exit **Time** submenu select the **Return** line and press the SEL push-button.

Date submenu

This submenu is divided into two items that allow the user to display or set the current date.

- **Date Adjust:** this item has to be selected after each power-up in order to set the current date. If the time and date have not been configured before, a message is displayed, that gives the choice to set the time and date or, to exit to the upper submenu. The user is asked to set the current date to be stored in the application memory. The date is displayed as **Year, Month, Week Nbr, Day Nbr** (number of the day in the year) with the selected day shown in the month. There is no default date since the user has to set the date at least once. Once the submenu has been selected, the user starts by setting the **Year**, then the **Month** and the day of the selected month. The **Month** and the **Year** are selected using the UP or DOWN push-button. For the day, the UP, DOWN, RIGHT and LEFT push-buttons can be used. Pressing the UP push-button will display the current value plus one, pressing the DOWN push-button will display the previous value. To confirm the selected month, the user has to press the SEL push-button and an automatic jump to the year configuration takes place. The same procedure is applicable for the year configuration. After configuring the day, pressing the SEL push-button will store the entered value and exit to the **Date** submenu. The current date value is then shown and the user can change the setting if required. The messages shown in *Figure 23*, *Figure 24* and *Figure 25* are successively displayed on the LCD when this submenu is selected.

Figure 23. Setting the Year

Month						Year
Week Nbr						Day Nbr
Mo	Tu	We	Th	Fr	Sa	Su
	1	2	3	4	5	6
7	8	9	10	11	12	13
14	15	16	17	18	19	20
21	22	23	24	25	26	27
28	29	30	31			
UP/DOWN: Set Year						

Figure 24. Setting the Month

Month						Year
Week Nbr						Day Nbr
Mo	Tu	We	Th	Fr	Sa	Su
	1	2	3	4	5	6
7	8	9	10	11	12	13
14	15	16	17	18	19	20
21	22	23	24	25	26	27
28	29	30	31			

UP/DOWN: Set Month

Figure 25. Setting the day of the month

Month						Year
Week Nbr						Day Nbr
Mo	Tu	We	Th	Fr	Sa	Su
	1	2	3	4	5	6
7	8	9	10	11	12	13
14	15	16	17	18	19	20
21	22	23	24	25	26	27
28	29	30	31			

All Key: Set Day

- **Date Show:** this item displays the current date. If the time and date have not been configured before, a message is displayed, that gives the choice to set the time and date or, to exit to the upper submenu. The message shown in *Figure 26* is displayed on the LCD when the submenu is selected (with the date already configured).

Figure 26. Exiting the Date Show submenu

Month						Year
Week Nbr						Day Nbr
Mo	Tu	We	Th	Fr	Sa	Su
	1	2	3	4	5	6
7	8	9	10	11	12	13
14	15	16	17	18	19	20
21	22	23	24	25	26	27
28	29	30	31			

To Exit Press SEL

To exit this submenu press the SEL push-button. To exit the **Date** submenu, select the **Return** line and press the SEL push-button.

Alarm submenu

Using this submenu, the user can configure the alarm activation time. When the alarm time value is reached, all the LEDs (LED1 to LED4) start flashing together and so for 30 seconds. This submenu is divided into two items to display or set the current alarm.

- **Alarm Adjust:** the alarm time activation is set in the same way as the time is set in the **Time Adjust** submenu. The following messages are successively displayed on the LCD when this submenu is selected:

Figure 27. Setting the alarm activation time

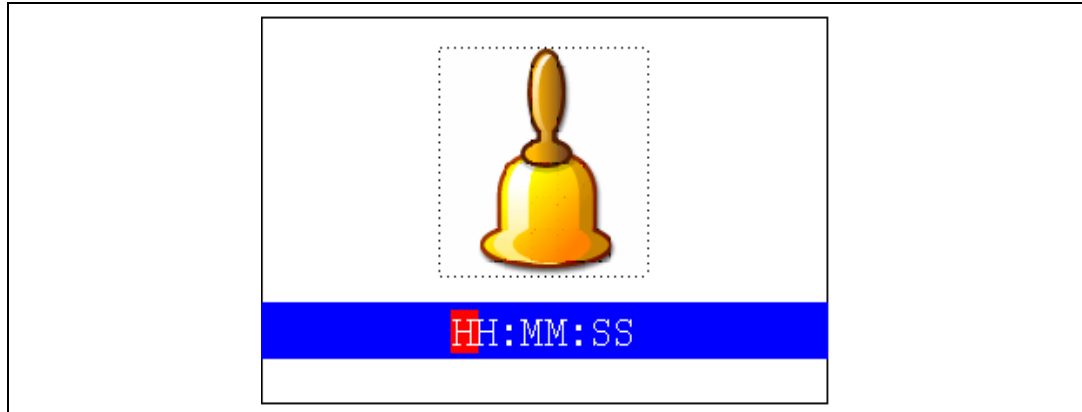

- **Alarm Show:** this item displays the current alarm time. The default Alarm activation time displayed after power-up and before setting in the **Alarm Adjust** submenu is 00:00:00. If the time and date have not been configured before, a message shown in [Figure 29](#) is displayed, when you press select it takes you back to the Alarm submenu. The message shown in [Figure 28](#) is displayed on the LCD when this submenu is selected.

Figure 28. Alarm Show submenu

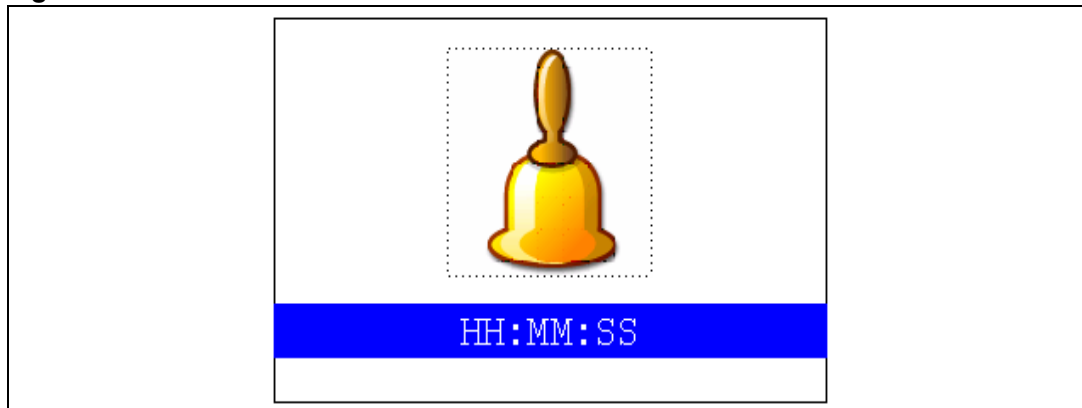

To exit the **Alarm Show** submenu press the SEL push-button. To exit the **Alarm** submenu, select the **Return** line and press the SEL push-button.

Note: In the **Alarm Adjust** and **Alarm Show** menus, if the time and date have not yet been configured, the message shown in [Figure 29](#) is displayed on the LCD screen.

Figure 29. The time and date need setting



2.4.3 Animation submenu

The STM32F103ZE(T6) microcontroller provides an FSMC memory interface that is used with a parallel LCD.

The **Animation** submenu is used to demonstrate the LCD control performance using the embedded FSMC interface. The application is a successive display of stored images. The result is a video-like animation.

Figure 30. Animation submenu

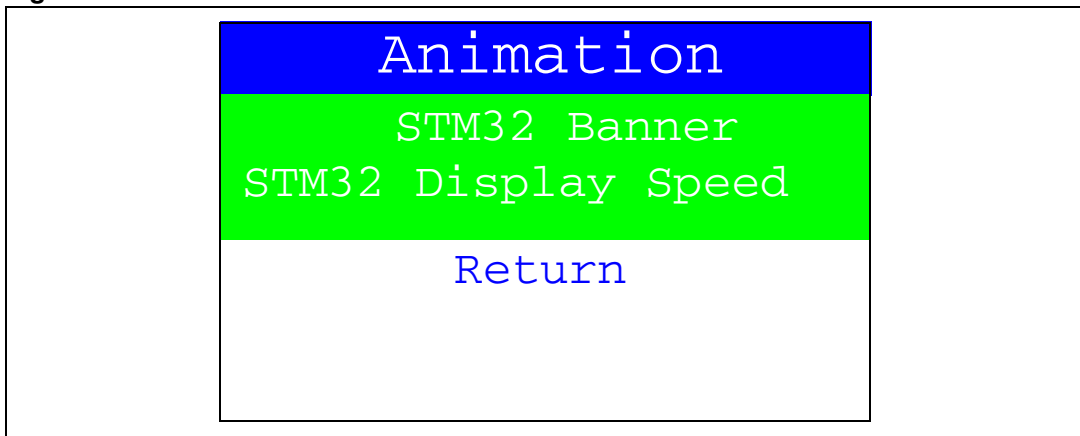

STM32 Banner

This STM32 Banner animation is composed of fifty images. These images are displayed at a rate equal to 12 frames per second (fps).

When the **STM32 Banner** menu is selected, the animation shown in *Figure 31* is displayed on the LCD screen.

Figure 31. STM32 Banner Animation

Once the STM32 Banner Animation submenu has been selected, the relative animation is displayed in a loop on the LCD screen.

If the SEL push-button is pressed while the animation is playing, the animation is stopped and the submenu shown in [Figure 32](#) is displayed.

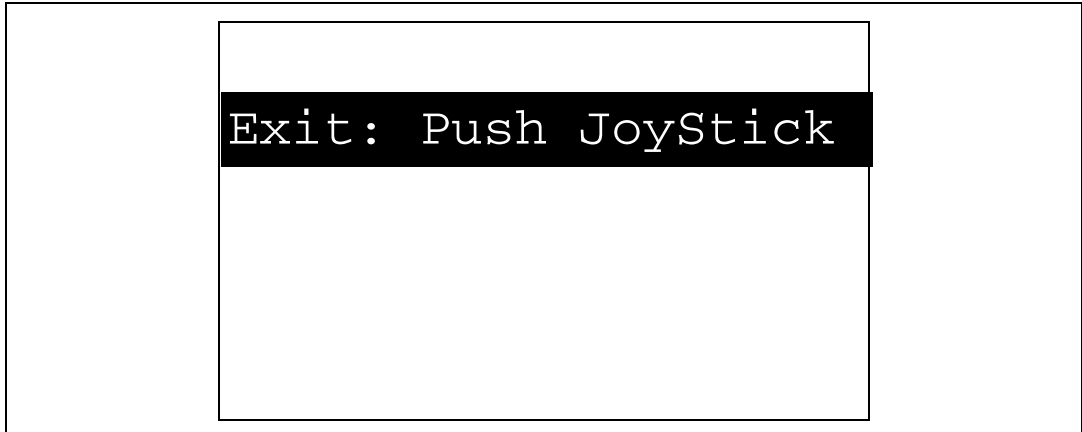
Figure 32. Exit submenu

If any push-button is pressed, the application returns to the **Animation** menu.

STM32 Display Speed

This submenu displays the set of STM32 presentation slides composed of 14 slides with a speed controlled through the RV1 trimmer. Increase or decrease the delay between two frames by adjusting RV1: the maximum delay is of about 1s when RV1 is at its maximum position.

When the **STM32 Display Speed** menu is selected, the animation shown in [Figure 33](#) is displayed on the LCD screen.

Figure 33. STM32 Display Speed

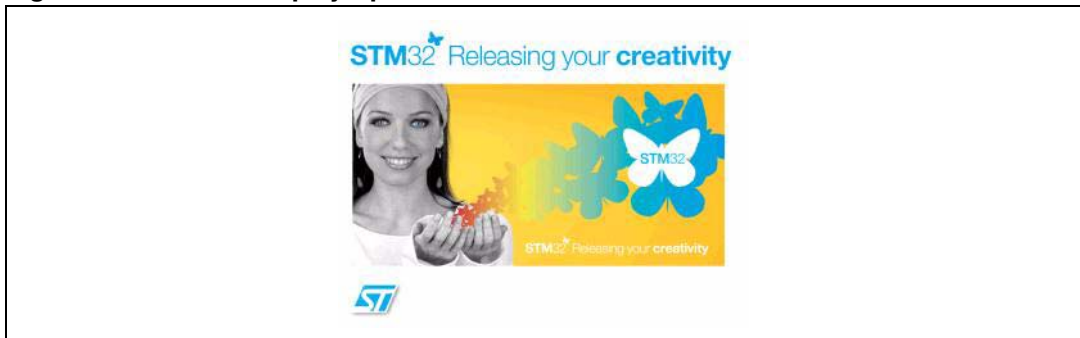

If the SEL push-button is pressed while the animation is playing, the animation is stopped and the Exit submenu shown in [Figure 34](#). is displayed.

Figure 34. Exit submenu

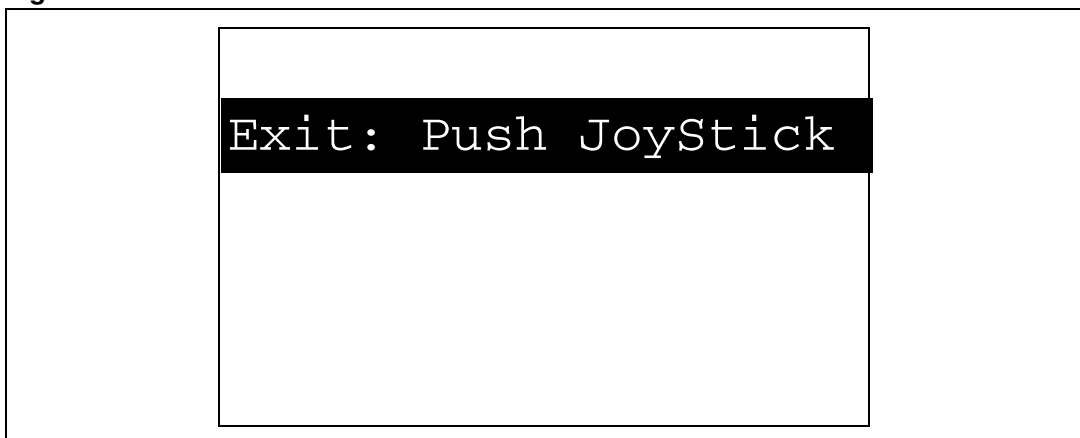

2.4.4 Wave Player submenu

The STM32F103ZE(T6) microcontroller provides SPI peripherals that support the I²S mode.

The **Wave Player** submenu is used to demonstrate the I²S feature. An audio codec is connected to the I²S interface to play a stored wave file.

By selecting Wave Player, the submenu shown in [Figure 35](#). is displayed.

Figure 35. Wave Player submenu

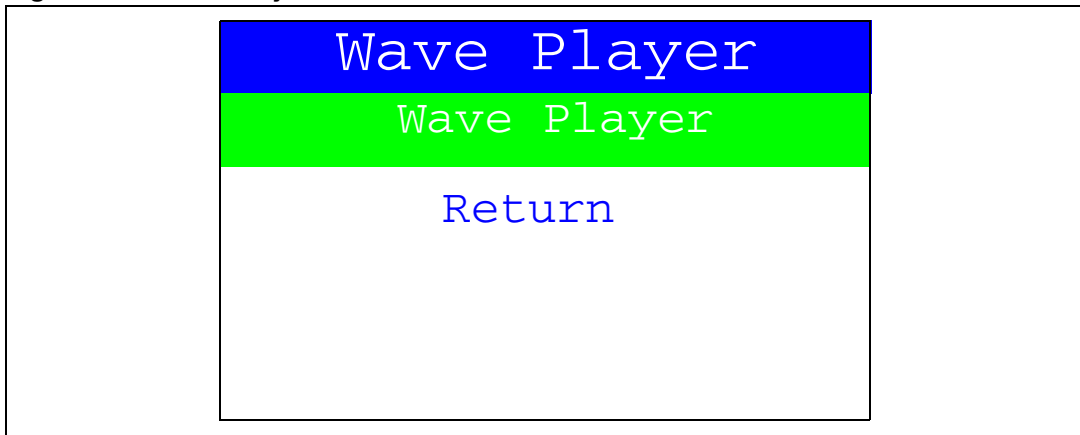

When Start is selected the wave player interface is displayed as shown in [Figure 36](#).

Figure 36. Wave Player interface

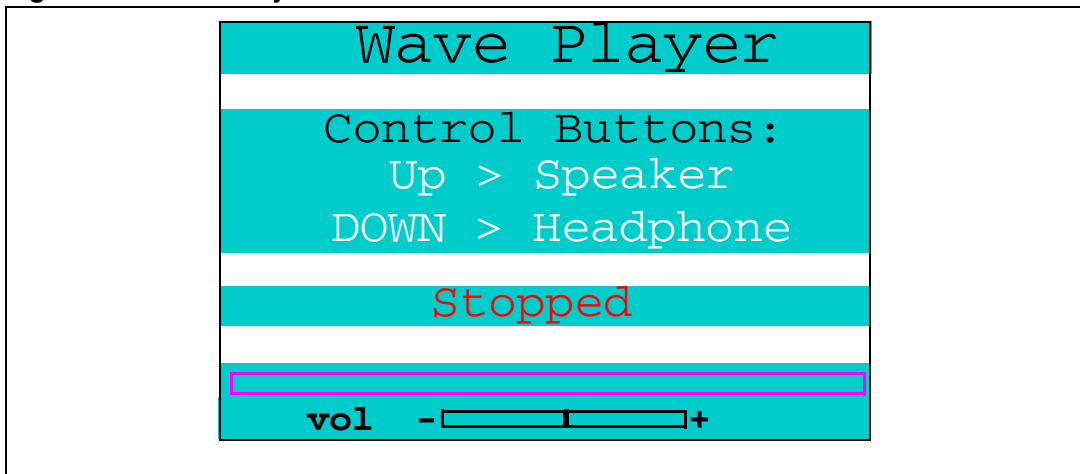

When the Wave Player starts, by default, the audio stream is stopped. In [Figure 36](#), the active push-buttons and their functions are displayed below "Control Buttons". For example, at start-up, pressing the "Up" JoyStick push-button causes the file to be played through the embedded speaker, whereas pressing the "Down" push-button causes the file the file to be played through the Headphone (in which case a headphone needs to be connected to the audio jack implemented on the evaluation board).

Once the play command is prompted, the submenu shown in [Figure 37](#). is displayed.

Figure 37. Wave Player Playing submenu

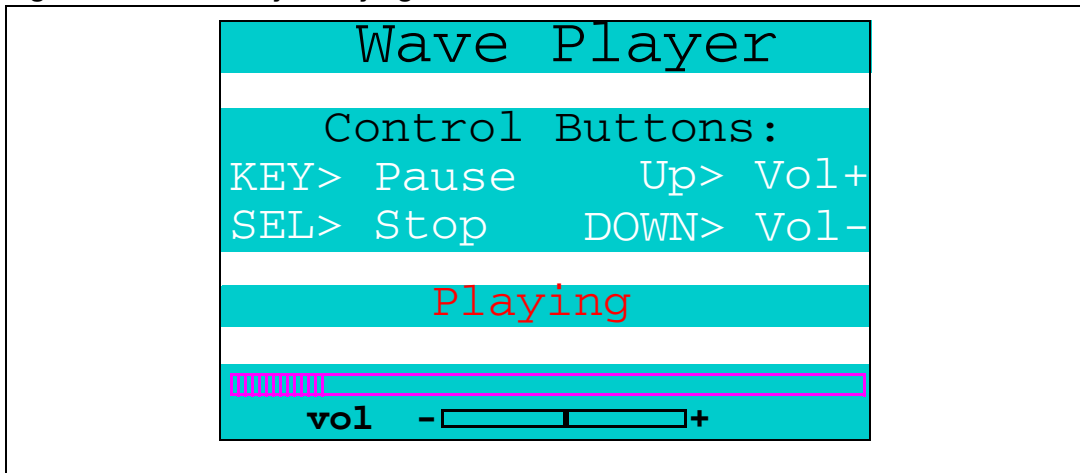

The Progress bar and the Volume bar are displayed at the bottom of the *Wave Player Playing submenu*. The Progress bar is updated every ~1% of the audio file duration and the Volume bar is updated each time the volume level is changed.

At this application level, pressing:

- the Key push-button pauses the audio stream
- the SEL push-button stops the audio stream
- the Up push-button increases the audio volume
- the Down push-button decreases the audio volume

When the audio stream is paused, the menu in *Figure 38* is displayed.

Figure 38. Pause submenu

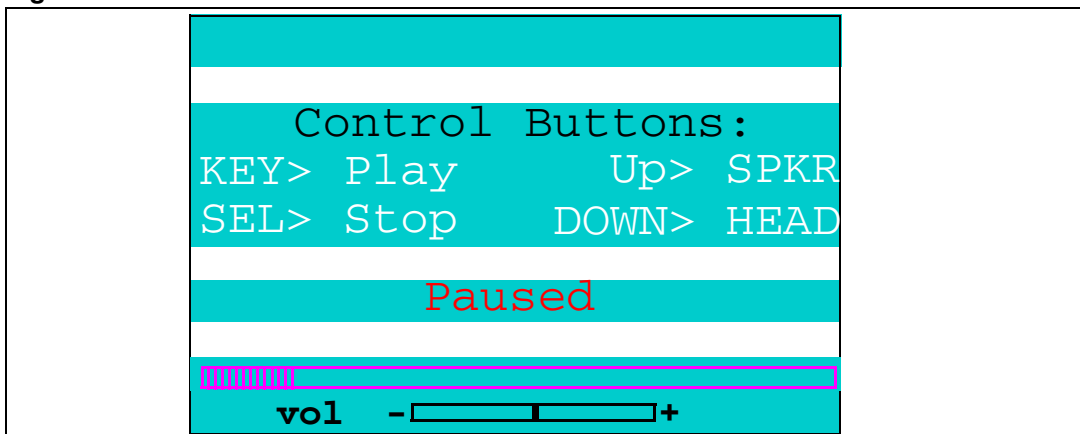

To resume playing, press the Key push-button. To change the audio output, press the Up JoyStick push-button to select the Speaker, and press the Down push-button to select the Headphone. Once the output device has been selected, the stream resumes playing immediately from the paused position and the menu shown in *Figure 37* is displayed.

When the audio stream is stopped, the stream position is reset and the menu shown in *Figure 36* is displayed.

When the volume is being increased or decreased (by pressing the Up/Down push-button) the Volume bar is updated accordingly at the same time.

A message may be displayed on the LCD screen when an error occurs during the application component initialization.

If the memory fails to communicate, the error menu shown in [Figure 39](#) is displayed and the user is prompted to reset the device.

Figure 39. Memory Error submenu

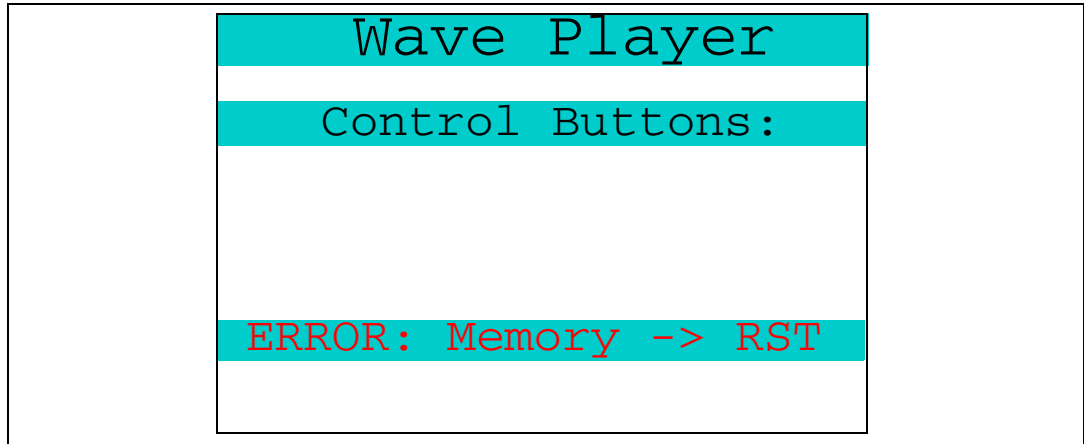

If communication with the codec through the I²C peripheral fails, the error message shown in [Figure 40](#) is displayed.

Figure 40. I²C Communication Error submenu

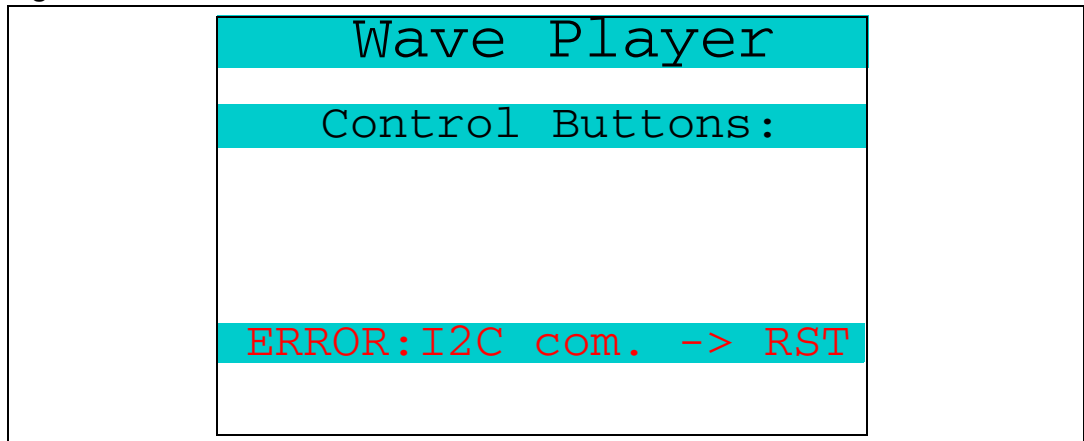

If the audio file is missing or if its format is not supported, the error message shown in [Figure 41](#) is displayed and a reset is required.

Figure 41. Audio file Error submenu

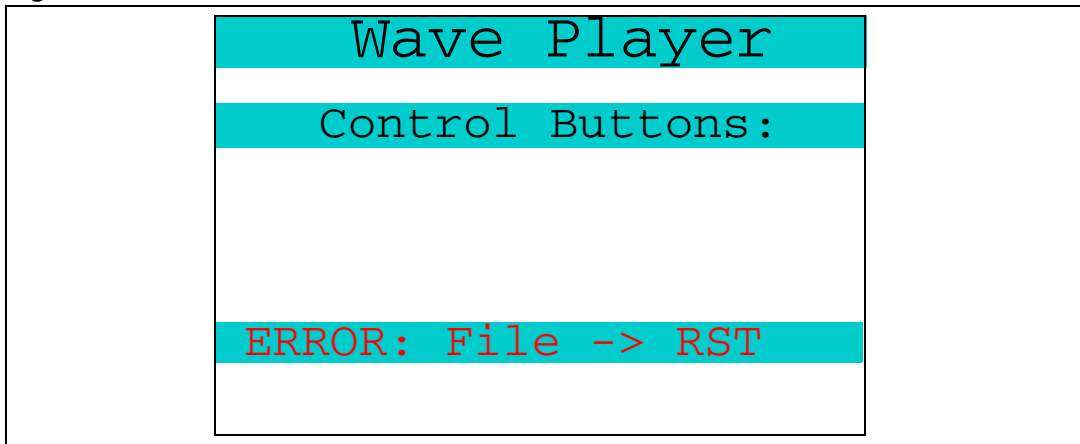

In all cases a manual reset might be performed using the Reset push-button. If the problem persists, the error source has to be checked.

2.4.5 USB mass storage

The STM32F103ZE(T6) microcontroller features a USB (universal serial bus) that provides a full-speed interface to a USB host PC.

The **USB Mass Storage** submenu is used to configure the USB interface for communication with the PC and, run the mass storage demo using either an MSD card or a NAND Flash.

Figure 42. USB Mass Storage submenu

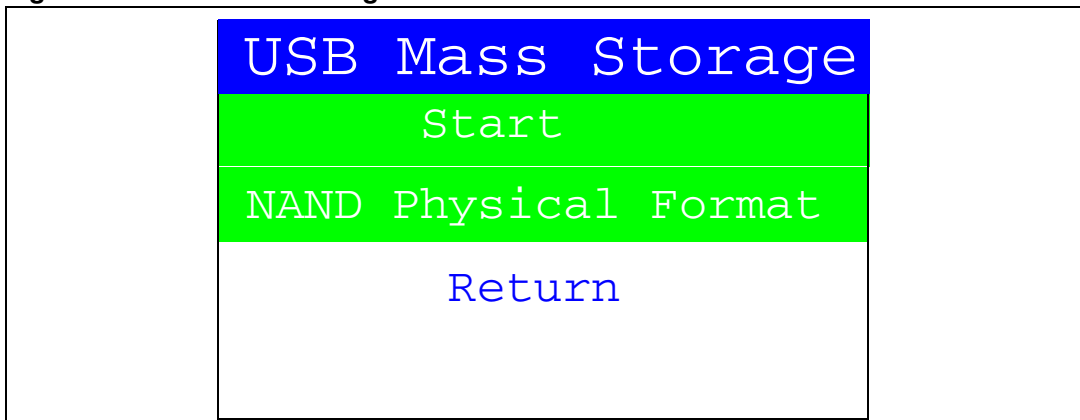

If the SEL push-button is pressed when Start is selected, the message shown in [Figure 43](#) appears on the LCD screen until the cable is plugged in.

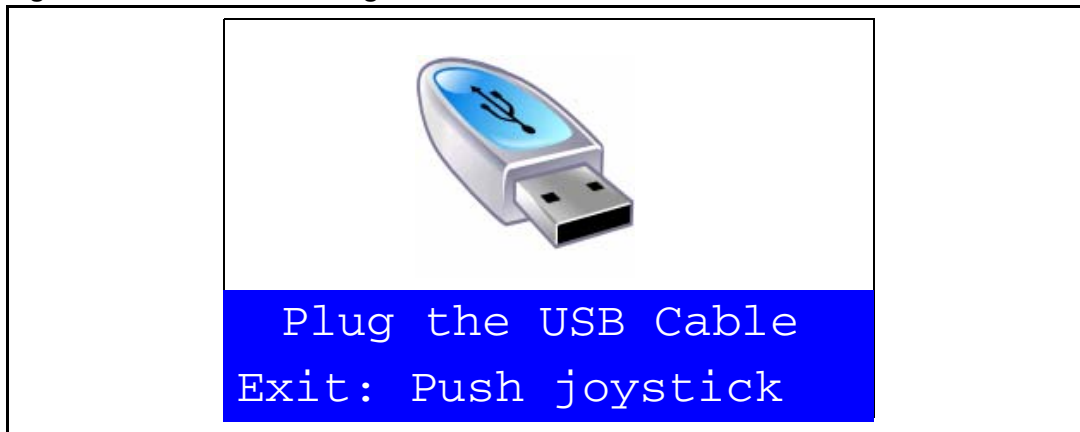
Figure 43. USB Mass Storage submenu selected

To return to the previous submenu, the user has to connect a USB cable between the USB connector type B (CN14) and the PC. If the user connects a cable or presses any joystick push-button, the message shown in [Figure 44](#) is displayed on the LCD.

Figure 44. USB cable connected

Once the cable has been connected, the PC recognizes the board as a mass storage device and consequently opens a window to show the contents of the MSD or NAND Flash mounted on the STM3210E-EVAL board. The user can transfer files between the MSD or NAND Flash and the PC.

NAND Physical Format submenu

This submenu erases all the NAND Flash contents. When the **NAND Physical Format** submenu is selected the message shown in [Figure 45](#) is displayed on the LCD.

Figure 45. NAND Erase operation

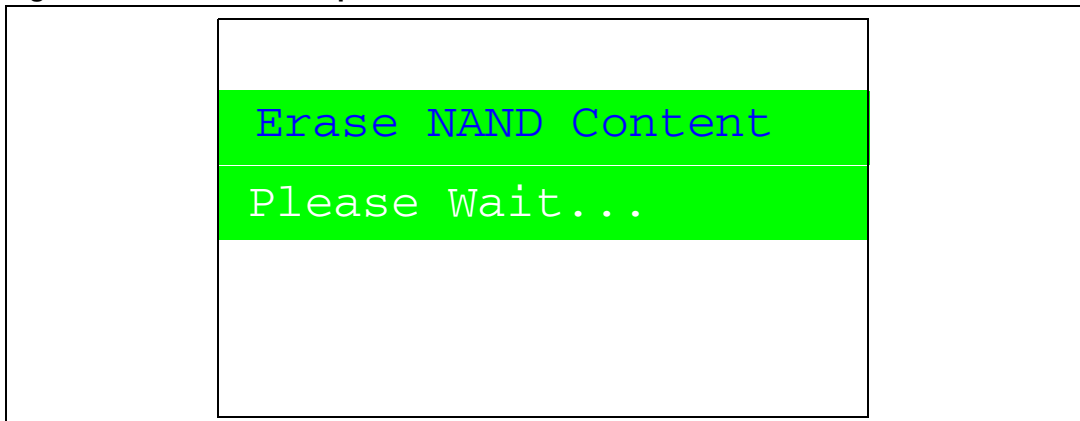

Once the NAND Erase operation has completed, the message shown in [Figure 46](#) is displayed on the LCD.

Note: In some cases the NAND Flash memory contents can be corrupted and thus this memory cannot be used as a mass storage device. The NAND Physical Format submenu erases all the NAND Flash memory contents and rebuilds the look-up table (LUT) used to translate logical addresses to physical ones and, to detect bad blocks in the NAND Flash memory. This operation could take a few seconds. Once this operation has been performed, the NAND Flash memory can be used as a mass storage device.

Figure 46. NAND Flash Erase operation completed

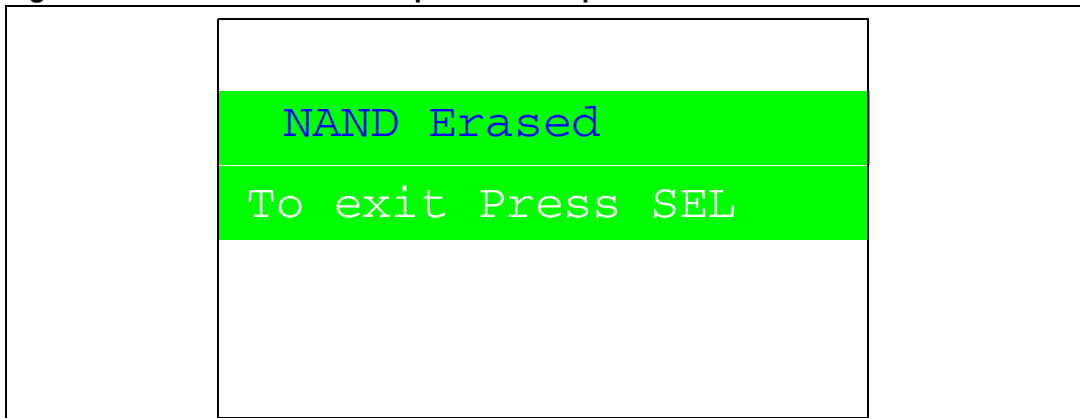

To exit this submenu and return to the **USB Mass Storage** submenu, press SEL.

Caution: The build look-up table (LUT) process used to translate logical addresses to physical ones and keep the block status is patented by STMicroelectronics. It is not allowed to use it outside the STM32F10xx firmware and it should not be reproduced without STMicroelectronics's agreement.

2.4.6 Low-power modes

The STM32F103ZE(T6) microcontroller provides different operating modes in which the power consumption is reduced. The purpose of this menu is to show the behavior of the microcontroller in different low-power modes. The Stop and Standby modes are taken as examples.

Stop mode menu

This menu allows the user to put the STM32F103ZE(T6) in the Stop mode. The software performs the specific instruction sequence needed to enter the Stop mode.

In this application, the STM32F103ZE(T6) can be made to exit the Stop mode in two ways as shown in [Figure 47](#).

Figure 47. Exiting the Stop mode

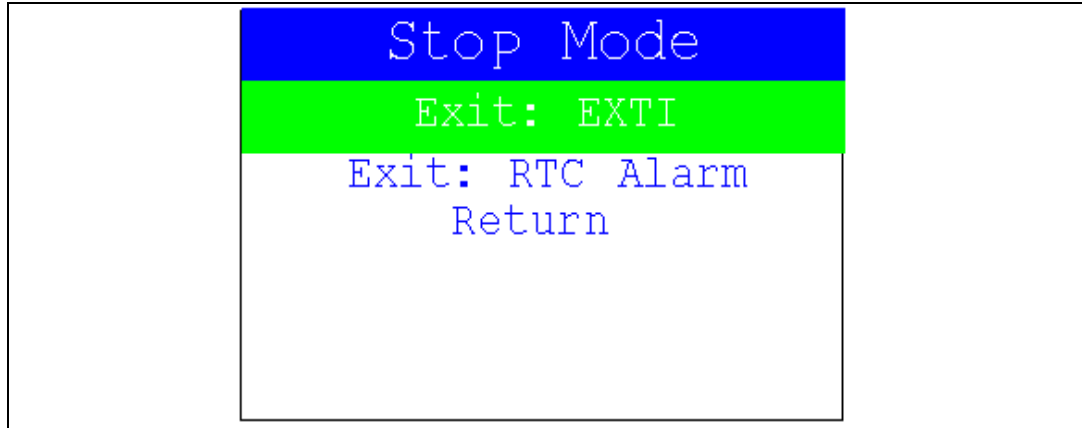

- In the first case, The EXTI Key button is used to make the MCU exit the Stop mode. Once the **Stop mode** submenu has been selected, the red LEDs continue blinking until the “SEL” push-button is pressed, and the system enters the Stop mode. When the MCU is in the Stop mode, the message shown in [Figure 48](#) is displayed on the LCD.

Figure 48. Stop mode entered

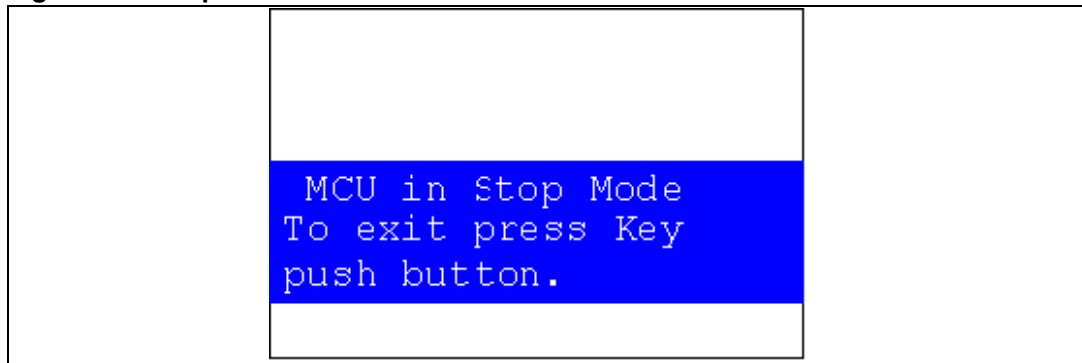

The MCU remains in the Stop mode until the Key push-button is pressed and the message shown in [Figure 49](#) is displayed on the LCD screen.

Once the Key push-button has been pressed, the MCU exits the Stop mode. The system clock is then set to 72 MHz and the application resumes execution.

Figure 49. MCU in the Stop mode

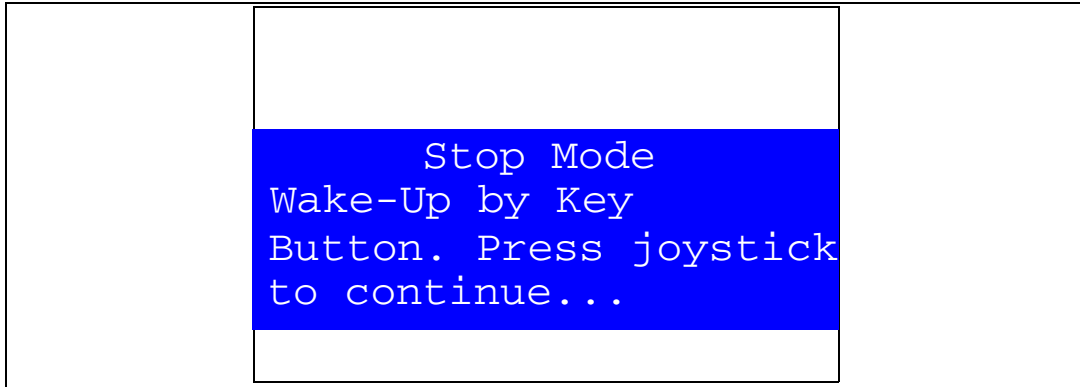

Note: if an RTC Alarm is generated while the MCU is in the Stop mode and the message shown in [Figure 49](#) is displayed (which means that the Key push-button needs to be pressed to exit the Stop mode), the RTC Alarm causes the MCU to exit the Stop mode. The message shown in [Figure 50](#) is then displayed.

Figure 50. RTC Alarm causes the MCU to exit the Stop mode

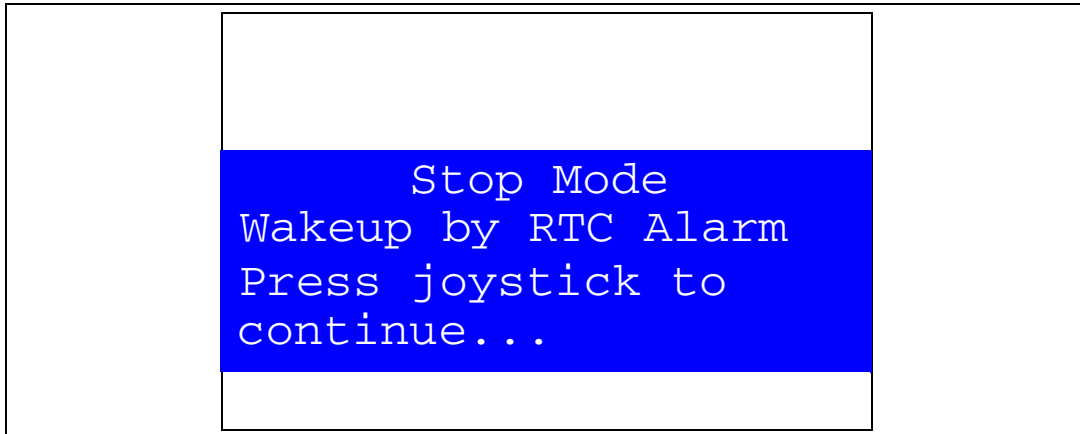

- In the second case, the RTC Alarm wakes up the MCU from the Stop mode after the programmed time has elapsed. When selecting this submenu, the user has to set the alarm to the time when the MCU is to exit the Stop mode. [Figure 51](#) shows how to set the wakeup time.

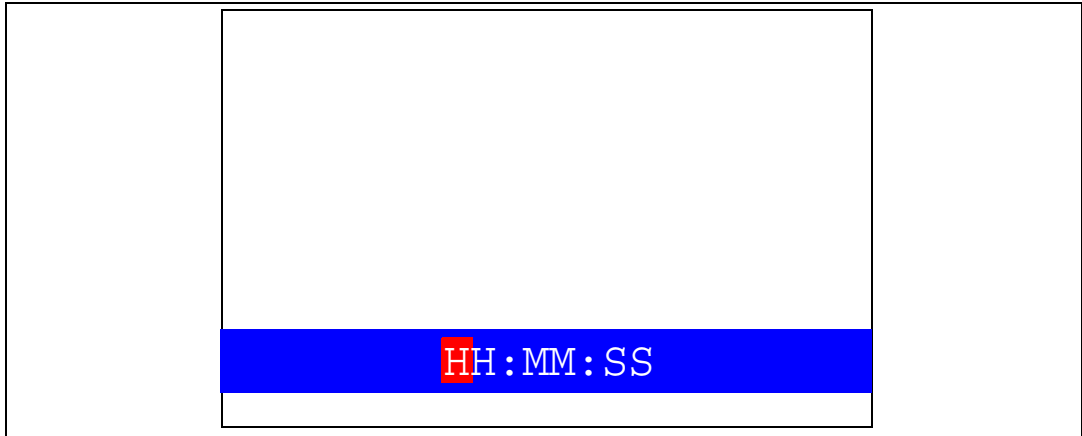
Figure 51. Setting the Wakeup time

Once the alarm has been configured, the red LEDs stop blinking and the system enters the Stop mode. The message shown in [Figure 52](#) is displayed on the LCD.

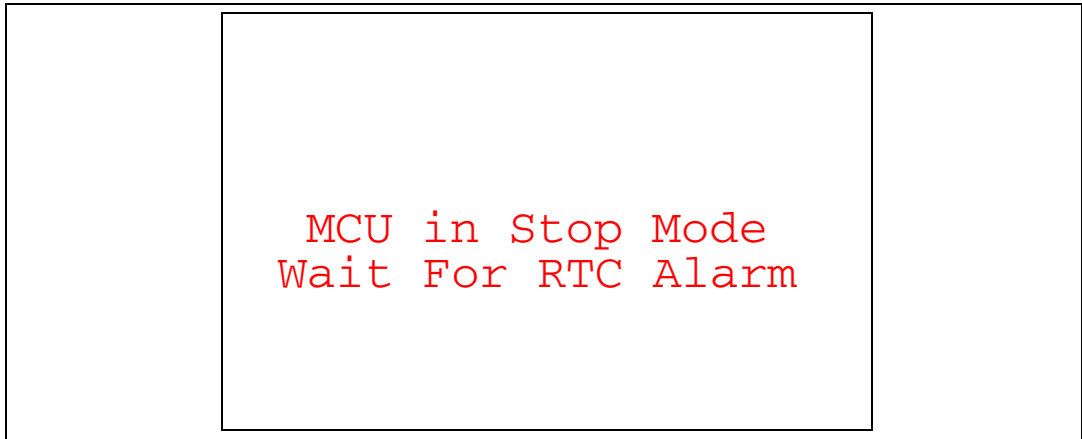
Figure 52. RTC Alarm wakeup configured

After the programmed time has elapsed, the system exits the Stop mode. The system clock is then set to 72 MHz and the application resumes execution. The message shown in [Figure 53](#) is displayed on the LCD screen.

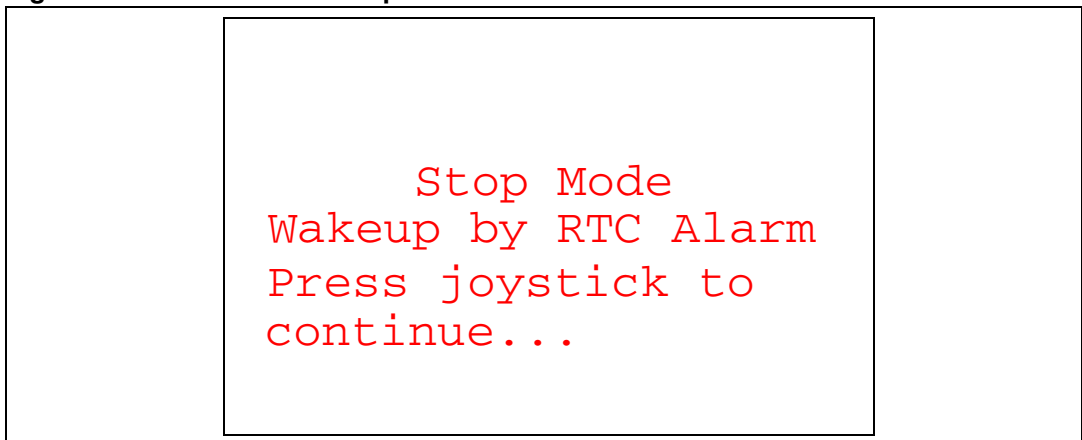
Figure 53. RTC Alarm wakeup

Note: if the Time and Date have not been set, the message shown in [Figure 54](#) is displayed on the LCD screen.

Figure 54. Time and Date configuration prompt

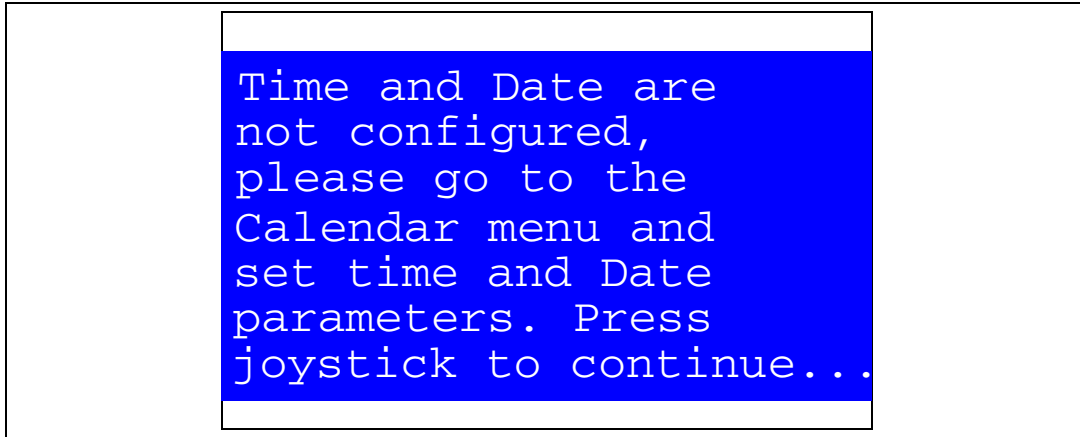

Standby mode menu

This menu allows the user to put the STM32F103ZE(T6) in the Standby mode. The software runs the specific instruction sequence needed by the STM32F103ZE(T6) to enter the Standby mode.

In this application, the STM32F103ZE(T6) can be made to exit the Standby mode in two ways as shown in [Figure 55](#).

Figure 55. Entering the Standby mode

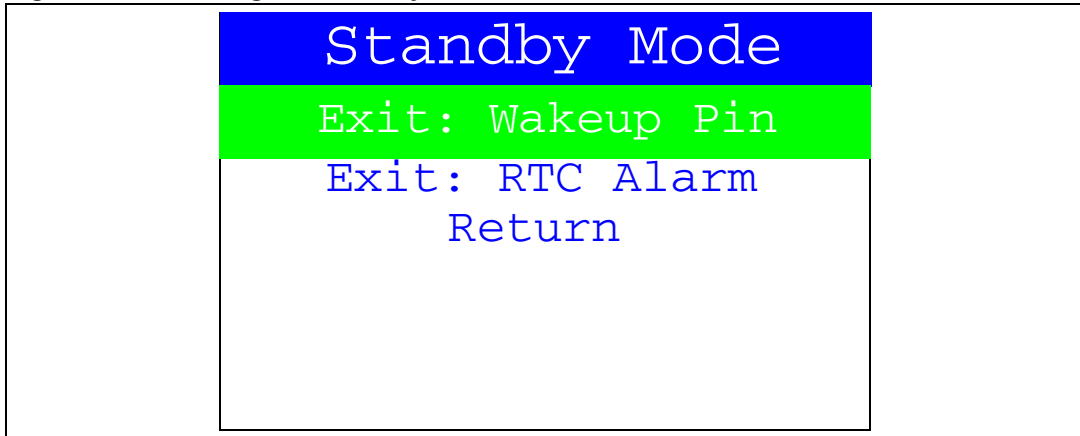

- In the first case, the Wakeup push-button is used to wake up the MCU from Standby mode.
Once the **Standby mode** submenu has been selected, the red LEDs continue blinking until the “SEL” push-button is pressed, and the system enters the Standby mode. When the MCU is in the Standby mode, the message shown in [Figure 56](#) is displayed on the LCD

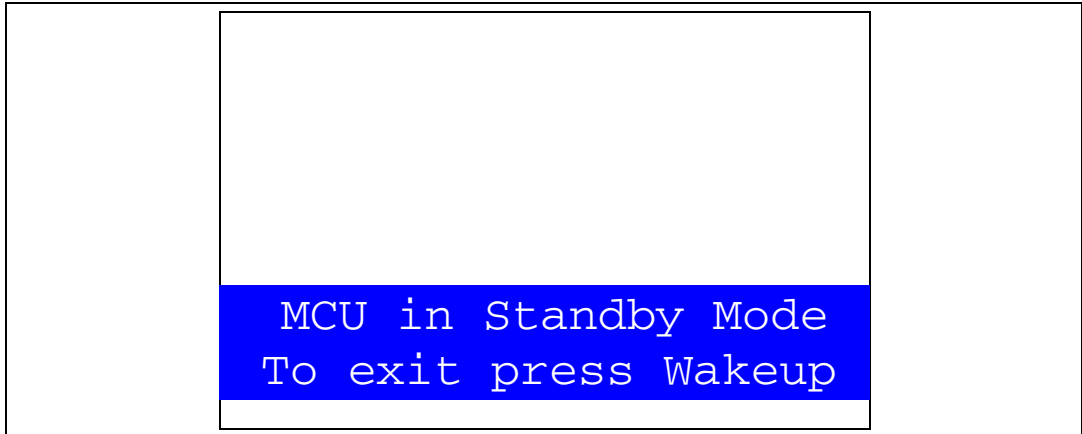
Figure 56. MCU in Standby mode

The MCU remains in the Standby mode until the Wakeup push-button is pressed. Once the Wakeup push-button has been pressed, the MCU exits the Standby mode and the system reset signal is generated.

Note: if an RTC Alarm is generated while the MCU is in the Standby mode and the message shown in [Figure 56](#) is displayed (which means that the Wakeup push-button needs to be pressed to exit the Standby mode), the RTC Alarm causes the MCU to exit the Standby mode and a system reset signal is generated.

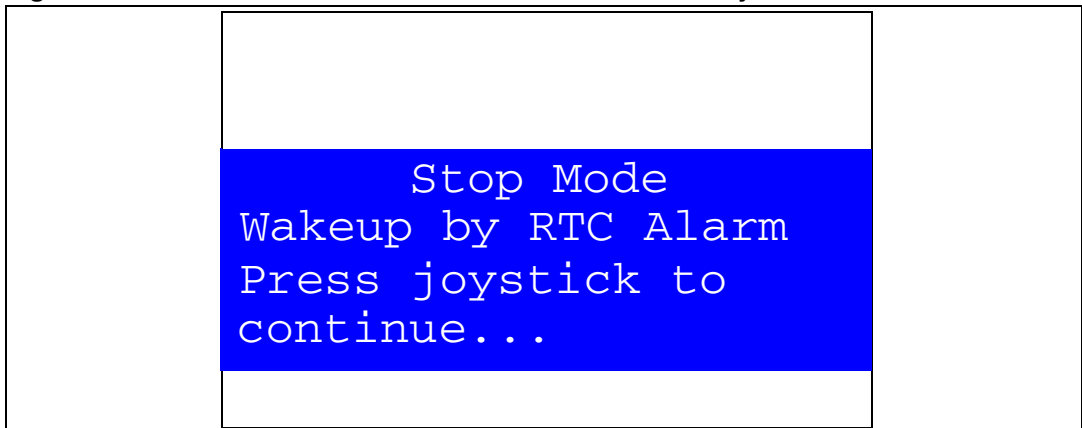
Figure 57. RTC Alarm causes the MCU to exit the Standby mode

- In the second case, the RTC Alarm wakes up the MCU from the Standby mode after the programmed time has elapsed. When selecting this submenu, the user has to set the alarm to the time when the MCU is to exit the Standby mode. [Figure 58](#) shows how to set the wakeup time.

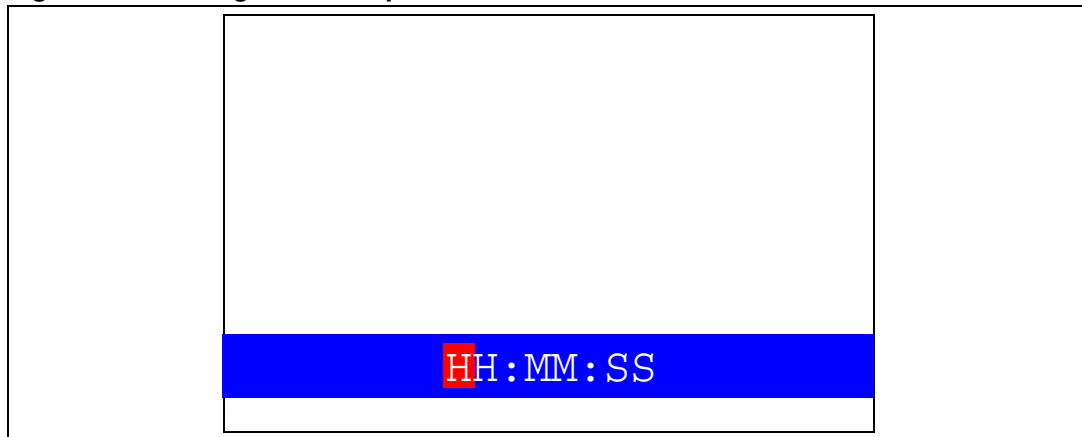
Figure 58. Setting the wakeup time

Once the alarm has been configured, The red LEDs stop blinking and the system enters the Standby mode. The message shown in [Figure 59](#) is then displayed on the LCD.

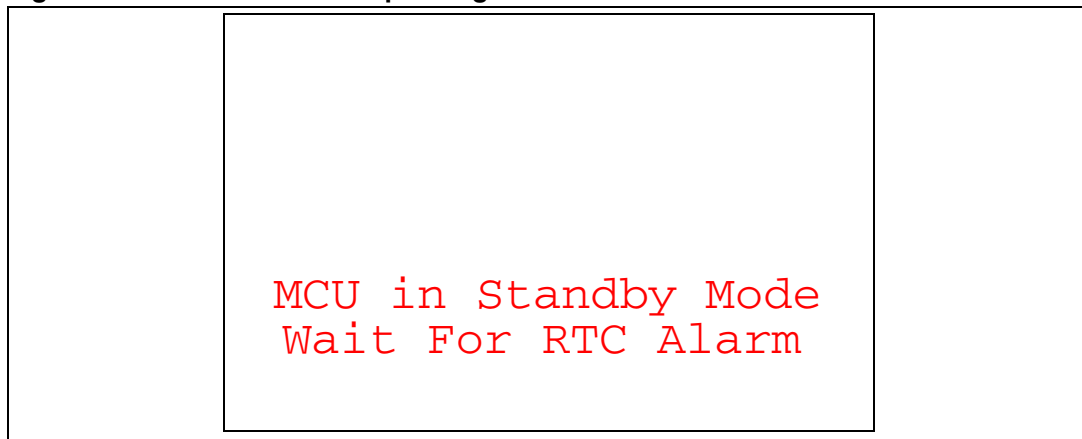
Figure 59. RTC Alarm wakeup configured

After the programmed timing has elapsed, the system exits the Standby mode and a system reset signal is generated.

Note: if the Time and Date have not been set, the message shown in [Figure 60](#) is displayed on the LCD screen.

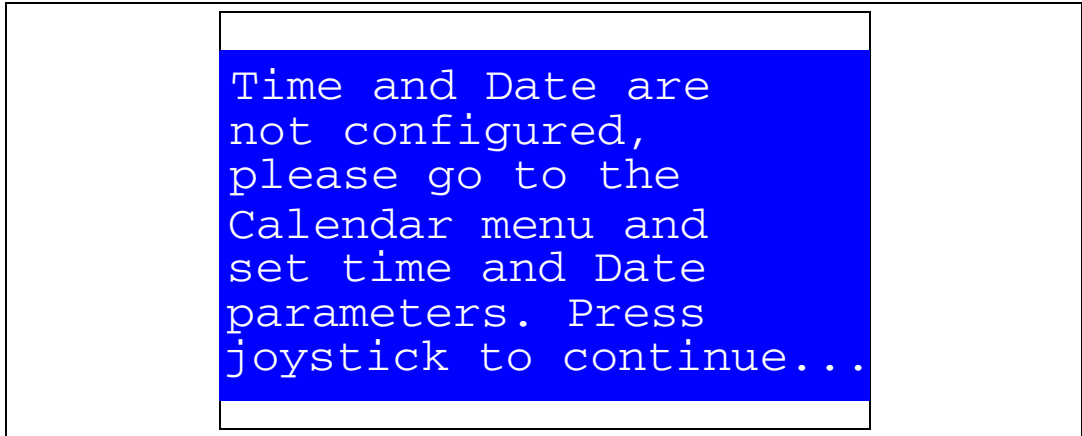
Figure 60. Time and Date configuration prompt

2.4.7 Smartcard

The STM32F103ZE(T6) microcontroller provides USART peripherals that support the Smartcard mode.

The **Smartcard** submenu is used to demonstrate the Smartcard control using the USART interface.

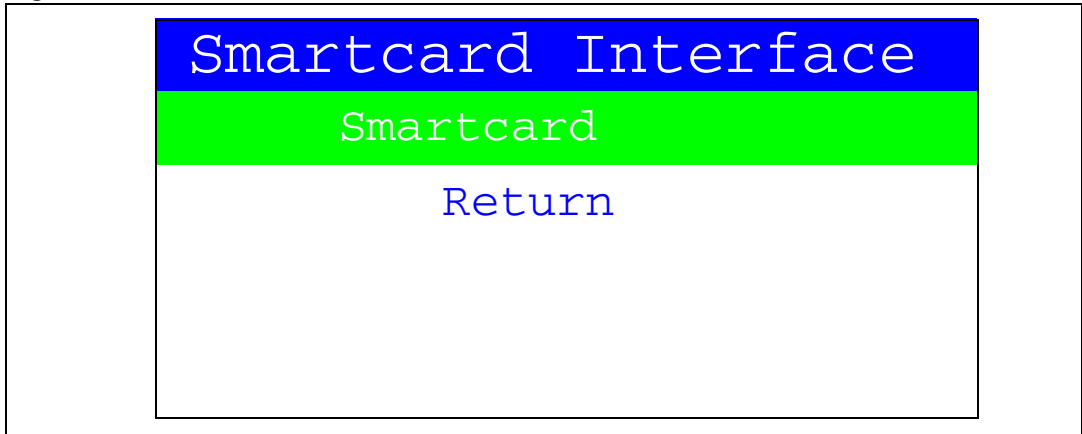
Figure 61. Smartcard submenu - 1

If the Smartcard submenu is selected, the message shown in [Figure 62](#) is displayed and the user is prompted to insert a smartcard.

Figure 62. Smartcard submenu - 2

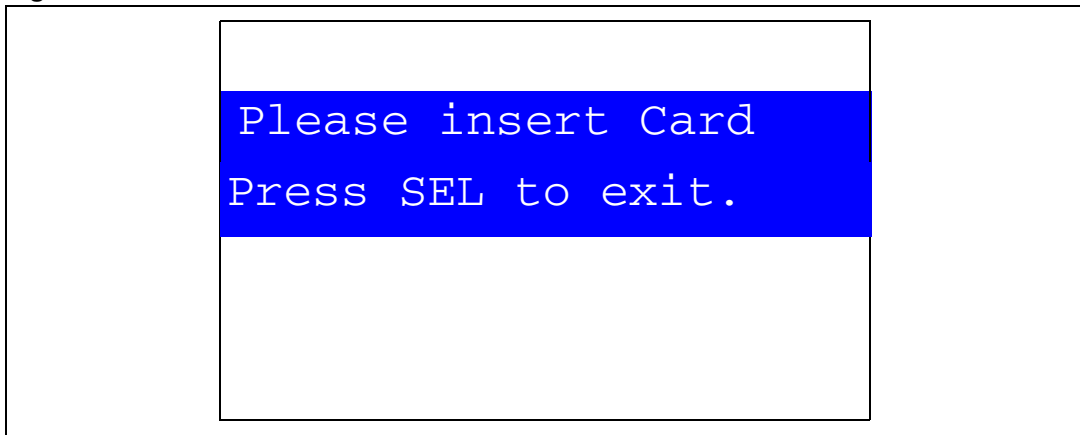

If a smartcard is inserted, the ATR is decoded and displayed on the LCD screen.

Figure 63. Smartcard submenu - 3

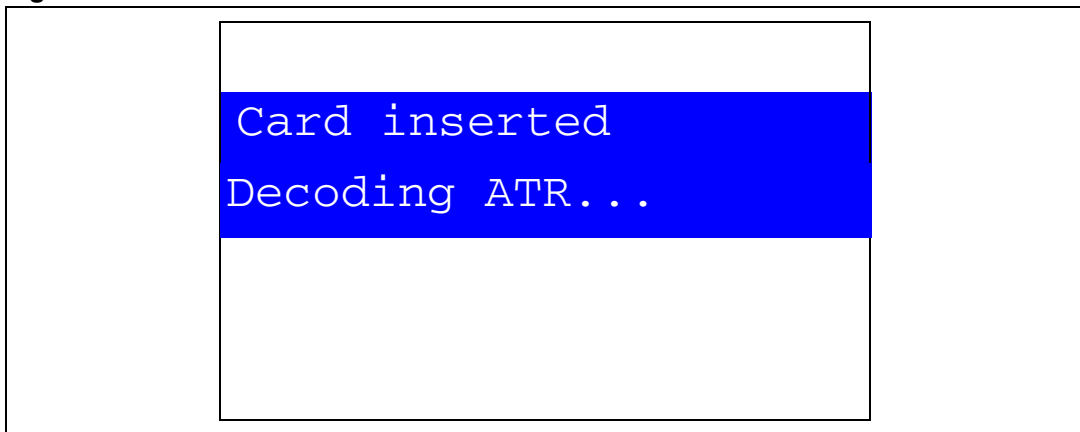

Once the smartcard answer to reset (ATR) is decoded and if the inserted card is ISO7816-3 T=0 compatible, the message shown in [Figure 64](#) is displayed.

Figure 64. Smartcard ATR decoded

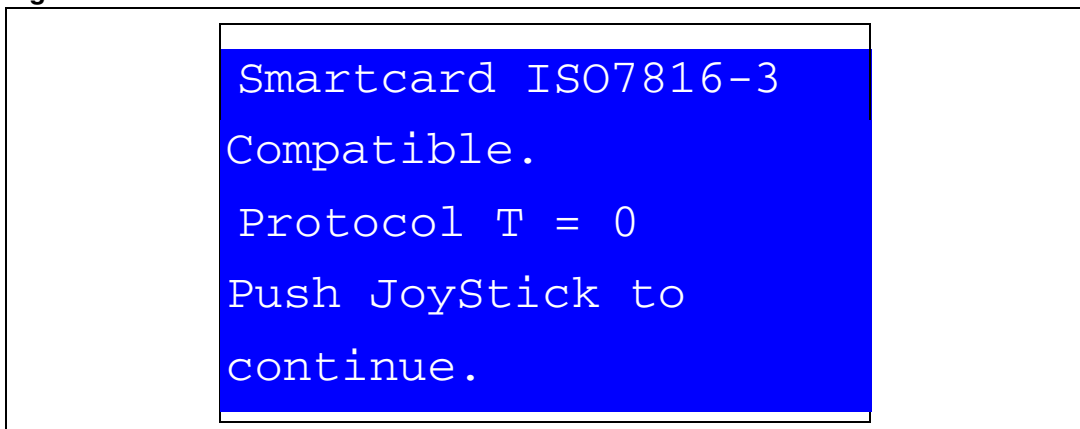

If the JoyStick is pushed, the ATR is displayed and the message shown in [Figure 65](#) is displayed.

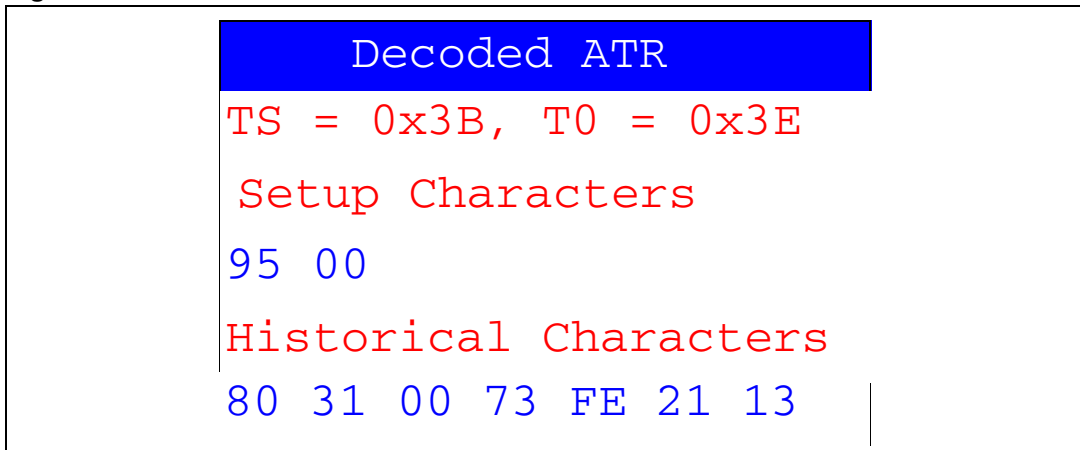
Figure 65. Smartcard ATR

```
Decoded ATR
TS = 0x3B, T0 = 0x3E
Setup Characters
95 00
Historical Characters
80 31 00 73 FE 21 13
```

Press any JoyStick key to exit this submenu.

If no smartcard is inserted and the SEL push-button is pressed, the message shown in [Figure 66](#) is displayed.

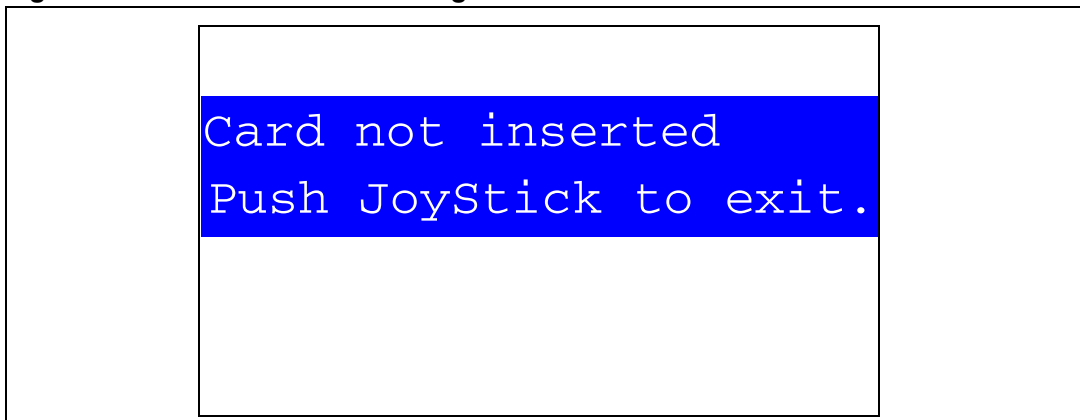
Figure 66. Smartcard Error message

```
Card not inserted
Push JoyStick to exit.
```

If the JoyStick push-button is pressed the application returns to the **Smartcard** submenu.

If a smartcard that is not ISO7816-3 T= 0 compatible is inserted, then the message shown in [Figure 67](#) is displayed.

Figure 67. Noncompatible smartcard error message

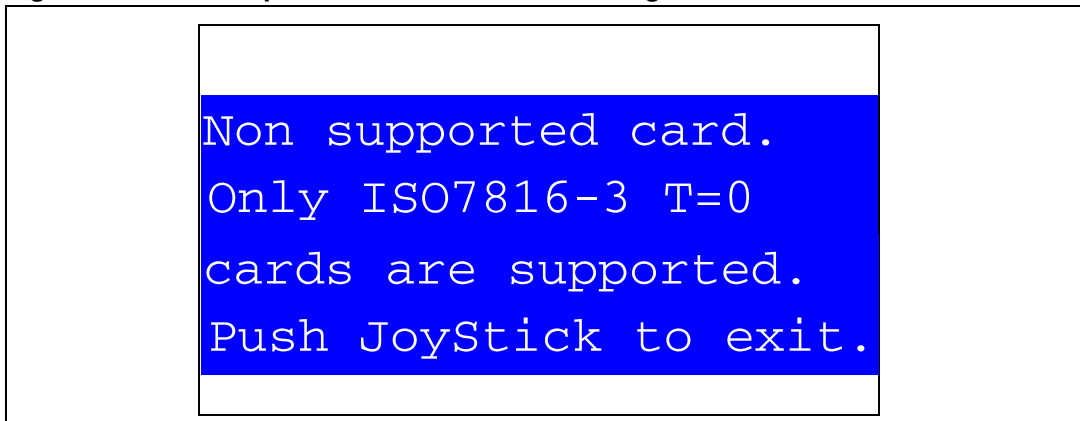

2.4.8 Thermometer

The STM32F103ZE(T6) microcontroller has two embedded I²C peripherals that can be connected to any device supporting the I²C protocol including the system management bus (SMBus) mode. An STLM75 (or a compatible device) I²C temperature sensor is mounted on the STM3210E-EVAL board and used to get instantaneous external temperature.

When the **Thermometer** submenu is selected, the message shown in [Figure 68](#) is displayed on the LCD.

Figure 68. Thermometer submenu selected

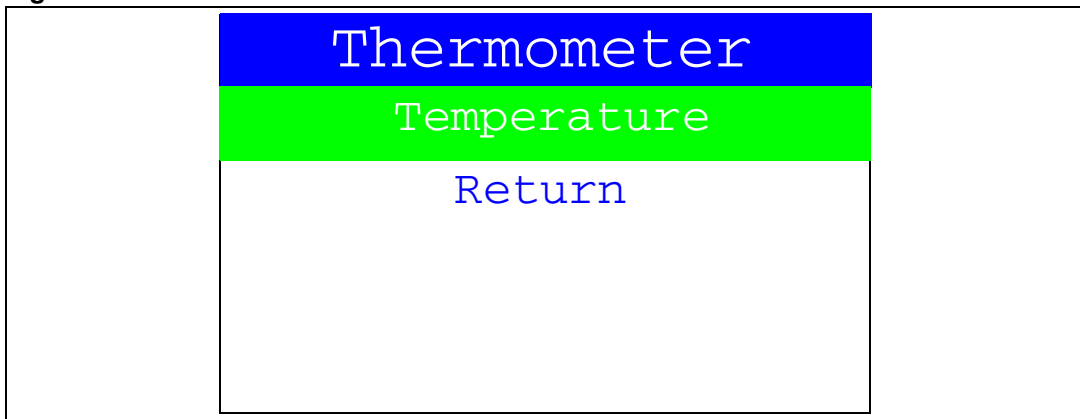

Once the **Temperature** submenu has been selected by pressing the SEL push-button, the temperature value is displayed in Celsius and Fahrenheit as shown in [Figure 69](#).

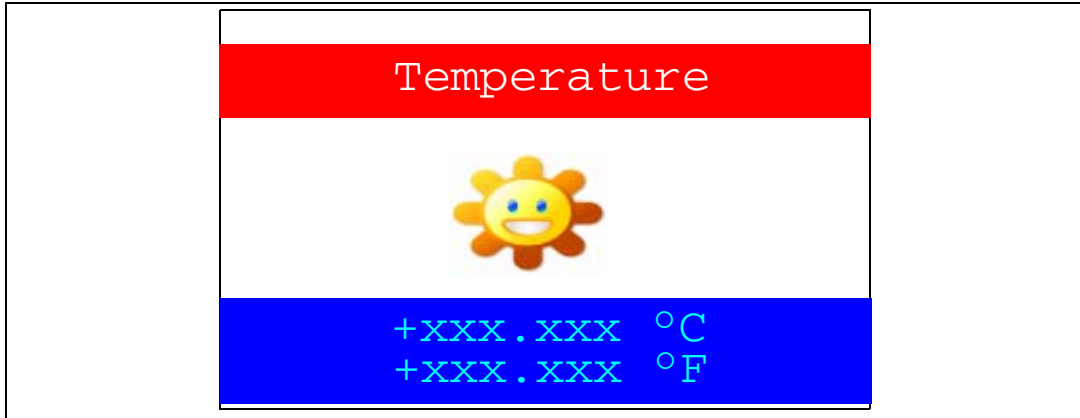
Figure 69. Temperature display

Press any key to return to the **Thermometer** submenu.

Note: Any hardware trouble with the temperature sensor is detected by a test. In this event, the message shown in [Figure 70](#) is displayed.

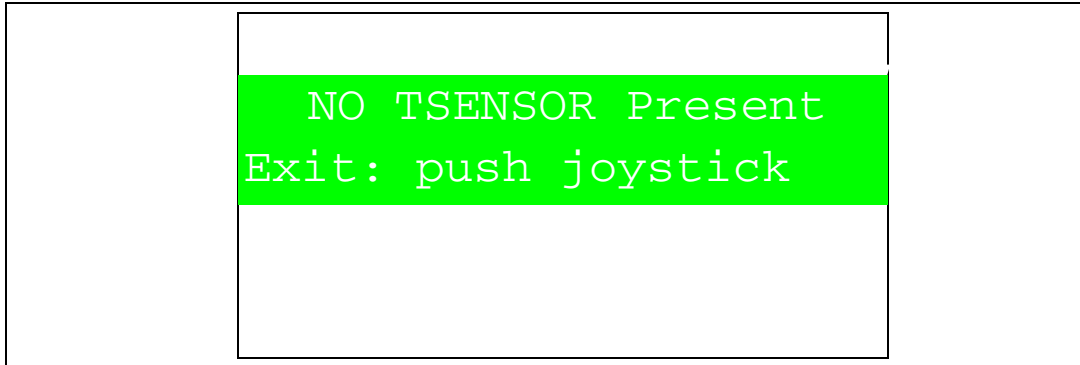
Figure 70. Temperature sensor error

2.4.9 Help submenu

This submenu provides help on the different keys used in the STM32F103ZE(T6) demo. When this submenu is selected, the message shown in [Figure 71](#) is displayed on the LCD screen.

Figure 71. Help submenu

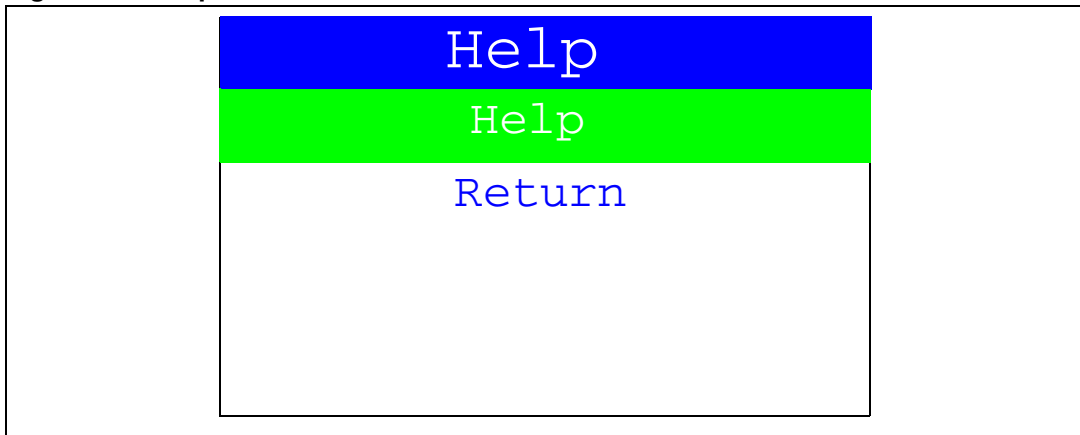

If the user presses on SEL, the image shown in *Figure 72* is displayed on the LCD screen.

Figure 72. Joystick buttons

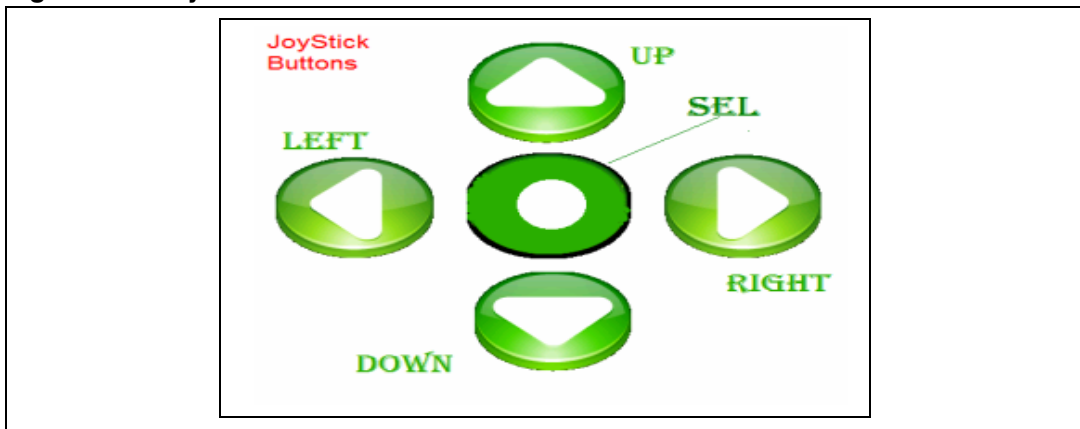

Press any joystick push-button to display the next help slide shown in *Figure 73*.

Figure 73. Second Help slide

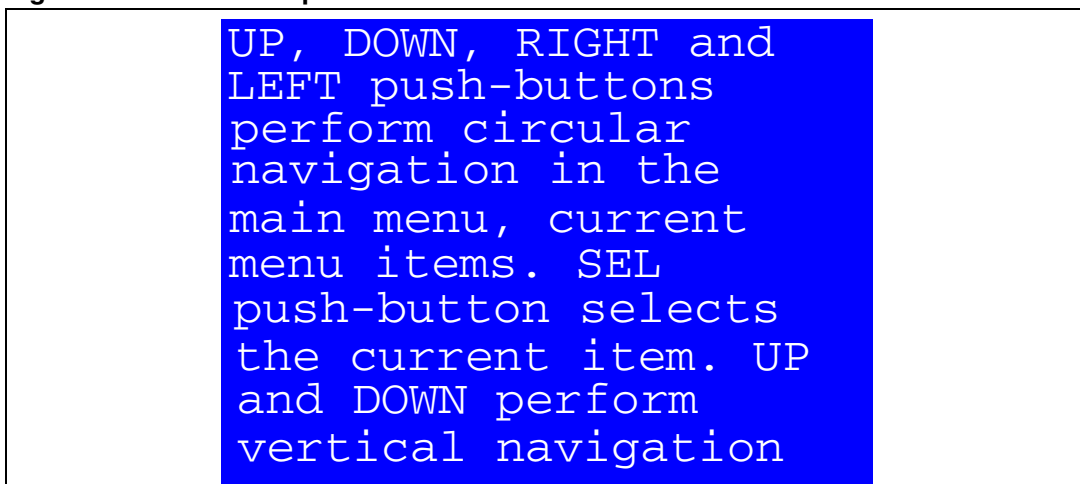

Press SEL to exit the slide and return to the **Help** submenu.

2.4.10 About submenu

This submenu shows the version of the STM32F103ZE(T6) demo software. When the **About** submenu is selected, the message shown in [Figure 74](#) is displayed on the LCD screen.

Figure 74. About submenu

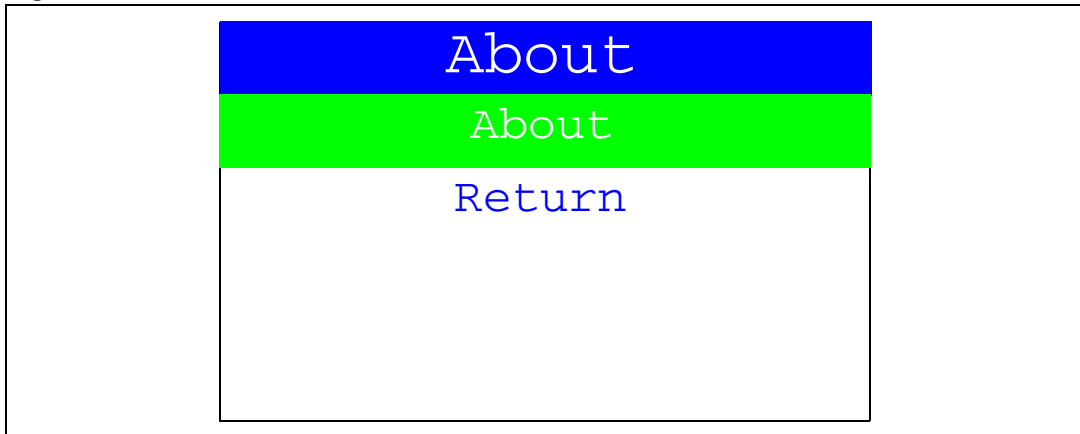

Pressing SEL then displays a message showing the STM3210E-EVAL demo version on the LCD screen.

3 Demonstration programming using the DFU

This section explains how to use the DFU (device firmware upgrade) application to program the demonstration application. It also describes the files needed for the STM3210E-EVAL board.

To save programming time using DFU, proceed as follows:

- use a certified USB 2.0 high-speed hub between STM3210E-EVAL board and your PC
- minimize the used PC RAM size by closing unused applications
- use an efficient PC

Note: When using the DFU application, make sure that in the STM3210E-EVAL board, jumper JP14 is in the position 2-3.

The USB DFU firmware and the demo firmware support three different NOR Flash memories. The DFU firmware will automatically detect which NOR Flash is being used, and configure its attributes. The supported NOR Flash memories are:

- ST M29W128F NOR Flash
- ST M29W128G NOR Flash
- Spansion S29GL128P NOR Flash

3.1 Programming the M29W128 NOR Flash memory

To program the NOR Flash memory, go through the following steps:

1. Load the DFU firmware project using your preferred Toolchain and load the DFU image using JTAG for the first time.
2. Connect the STM3210E-EVAL board to the PC with a USB cable. The first time this is done, you will be asked to install a driver for the board. The driver is already available in the installation directory.

Hold down the Key push-button on the STM3210E-EVAL board to enter the DFU mode.

3. Run the *DfuSeDemo.exe* program
4. In the **Action (Select Target(s))** field, select **NOR Flash: M29W128** and in the **Upgrade or Verify Action** field, click on the *Choose...* button as shown in [Figure 75](#).

Figure 75. Programming the NOR Flash memory

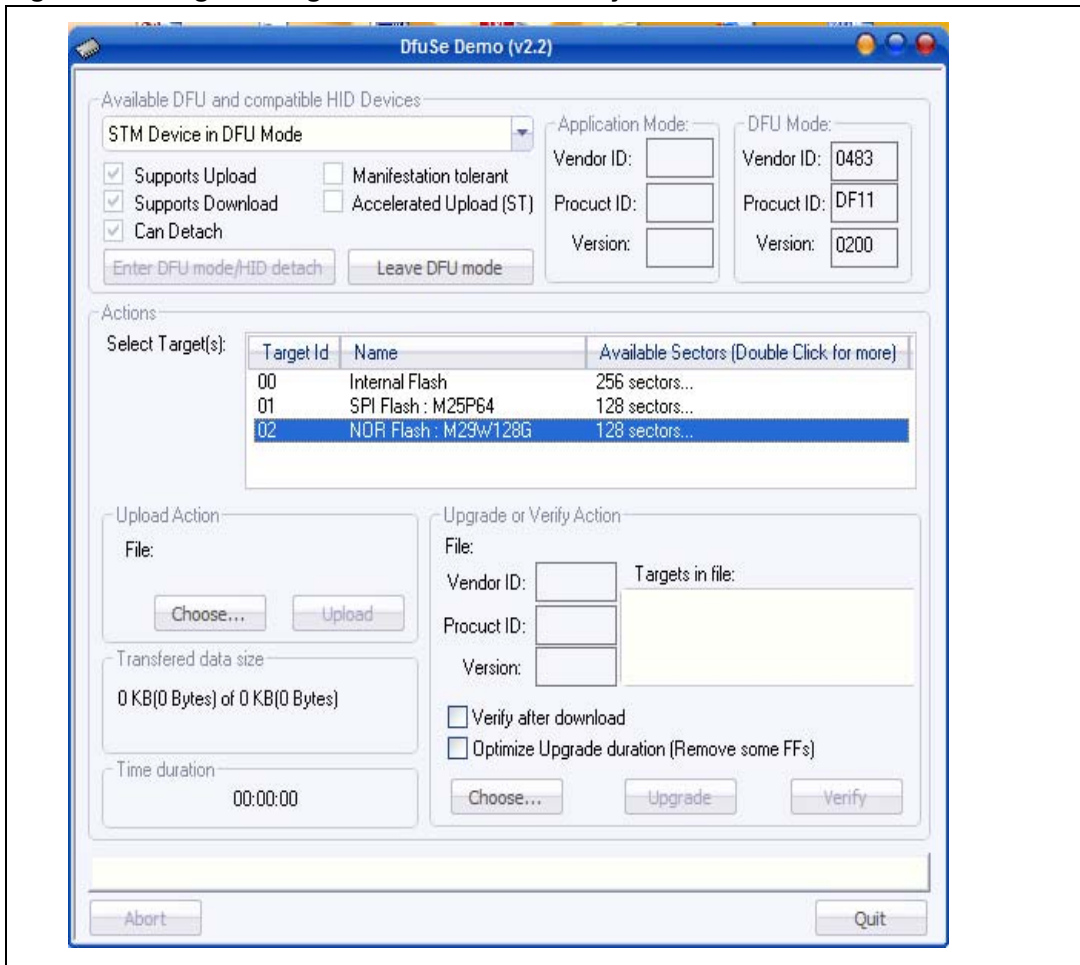

5. Select the **STM3210E-EVAL_Demo_NORFlash_V1.0.dfu** file, as shown in [Figure 76](#).

Figure 76. Selecting the *STM3210E-EVAL_Demo_NORFlash_V1.0.dfu* file

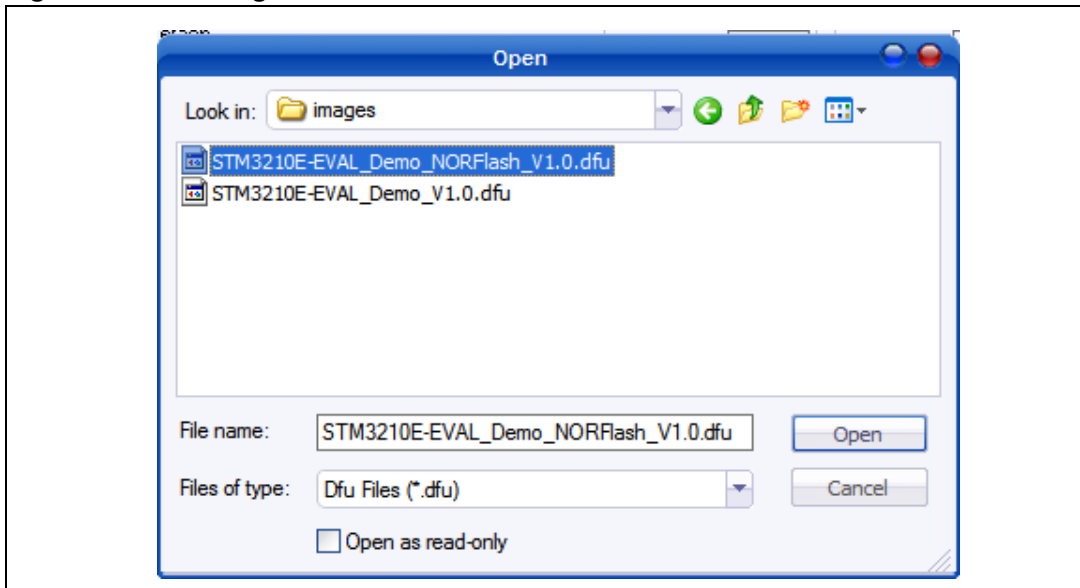

- 6. Then click on the Upgrade button. A dialog window will appear. Select Yes to continue (see [Figure 77](#)).

Figure 77. Click Yes to continue

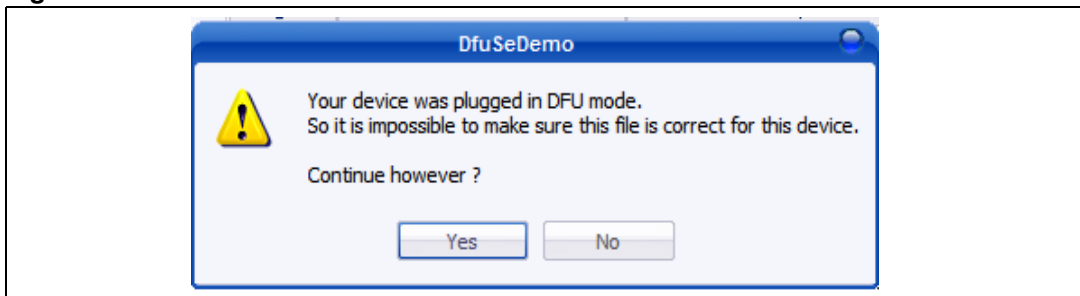

- 7. At this step the M29W128 NOR Flash memory programming will start as shown in [Figure 78](#).

Figure 78. NOR Flash memory programming

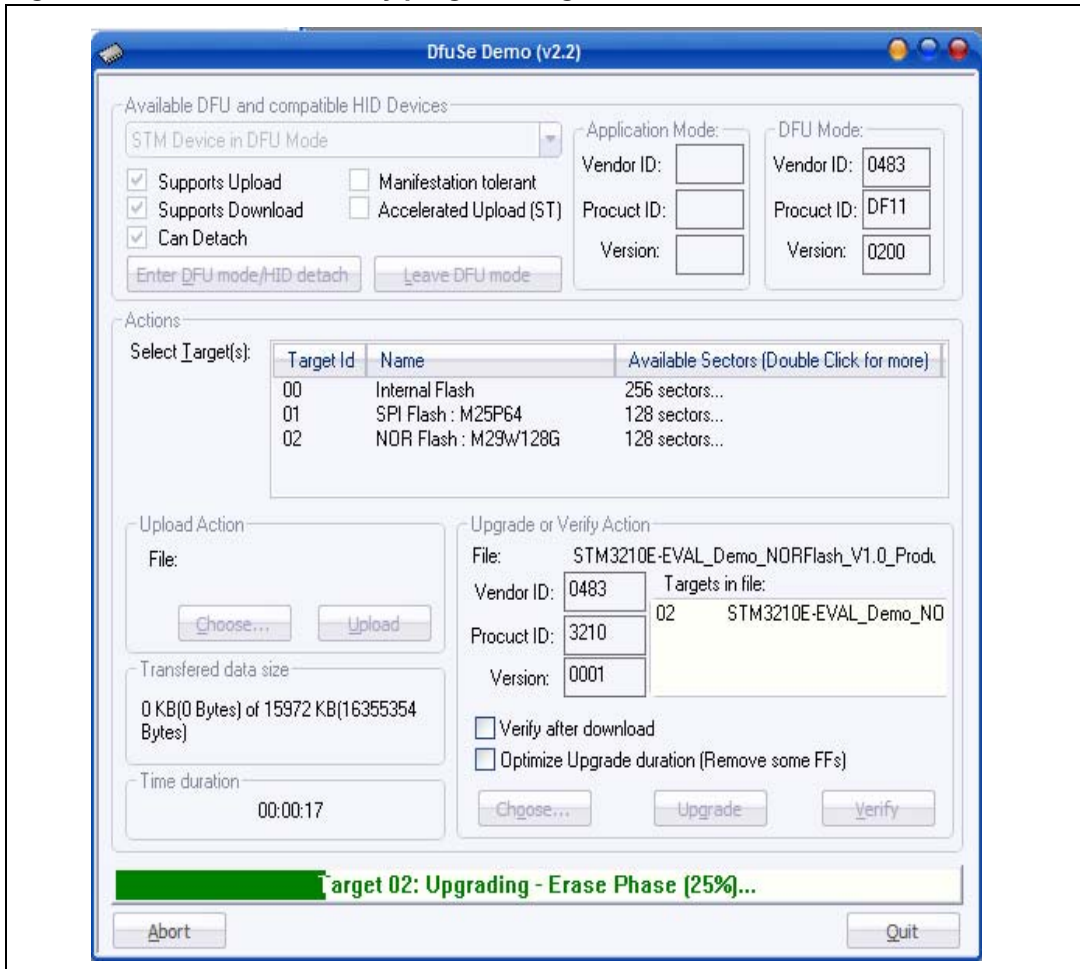

3.2 Demo programming

To program the **STM3210E-EVAL_Demo_V1.0.dfu** file in the internal Flash memory, go through the following steps:

1. When the NOR Flash memory has finished programming, in the **Action (Select Target(s))** field, select *Internal Flash* and in the **Upgrade or Verify Action** field, click on the *Choose...* button.

Figure 79. Programming the demo

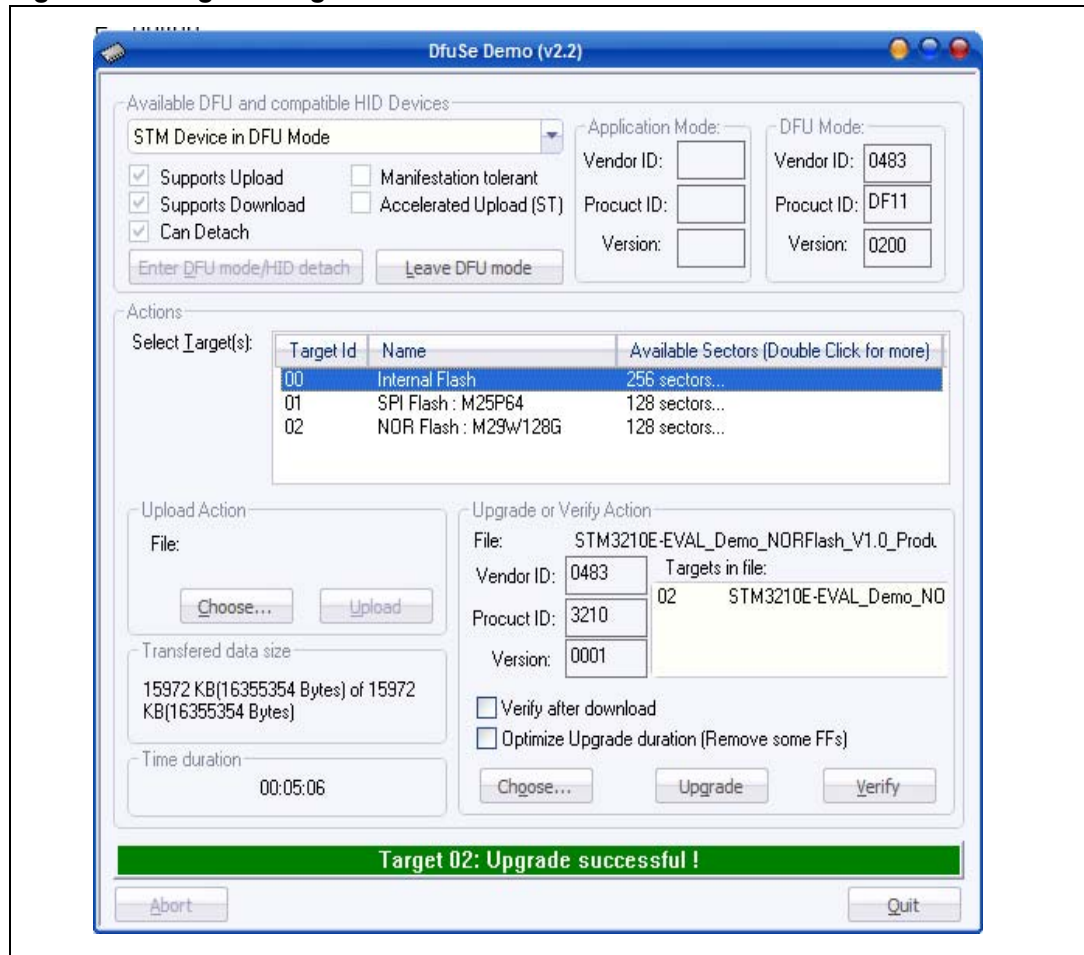

2. Select the STM3210E-EVAL_Demo_V1.0.dfu file, as shown in [Figure 80](#).

Figure 80. Selecting the STM3210E-EVAL_Demo_V1.0.dfu file

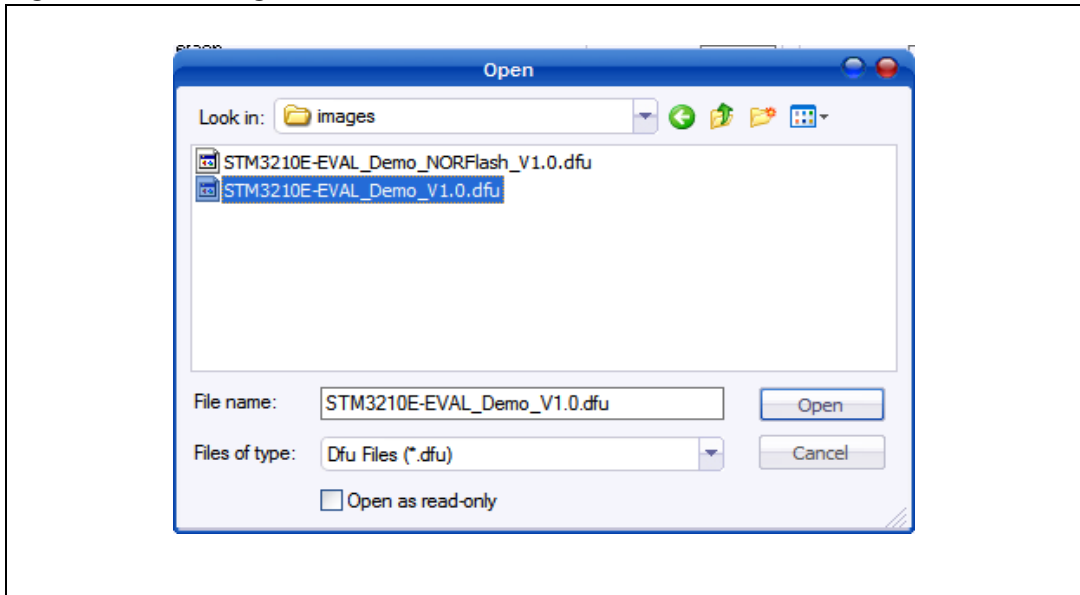

3. Then click on the *Upgrade* button. A dialog window will appear. Select *Yes* to continue.

Figure 81. Click Yes to continue

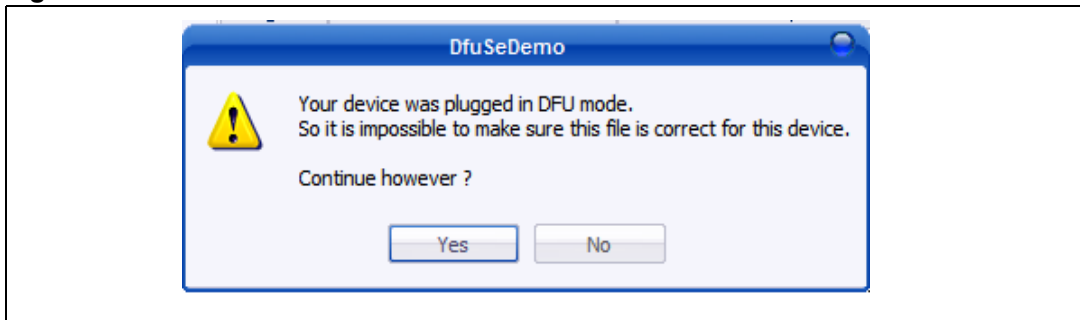

- 4. At this step the STM32F103ZE(T6)'s internal Flash memory programming starts as shown in [Figure 82](#).

Figure 82. Internal Flash memory programming

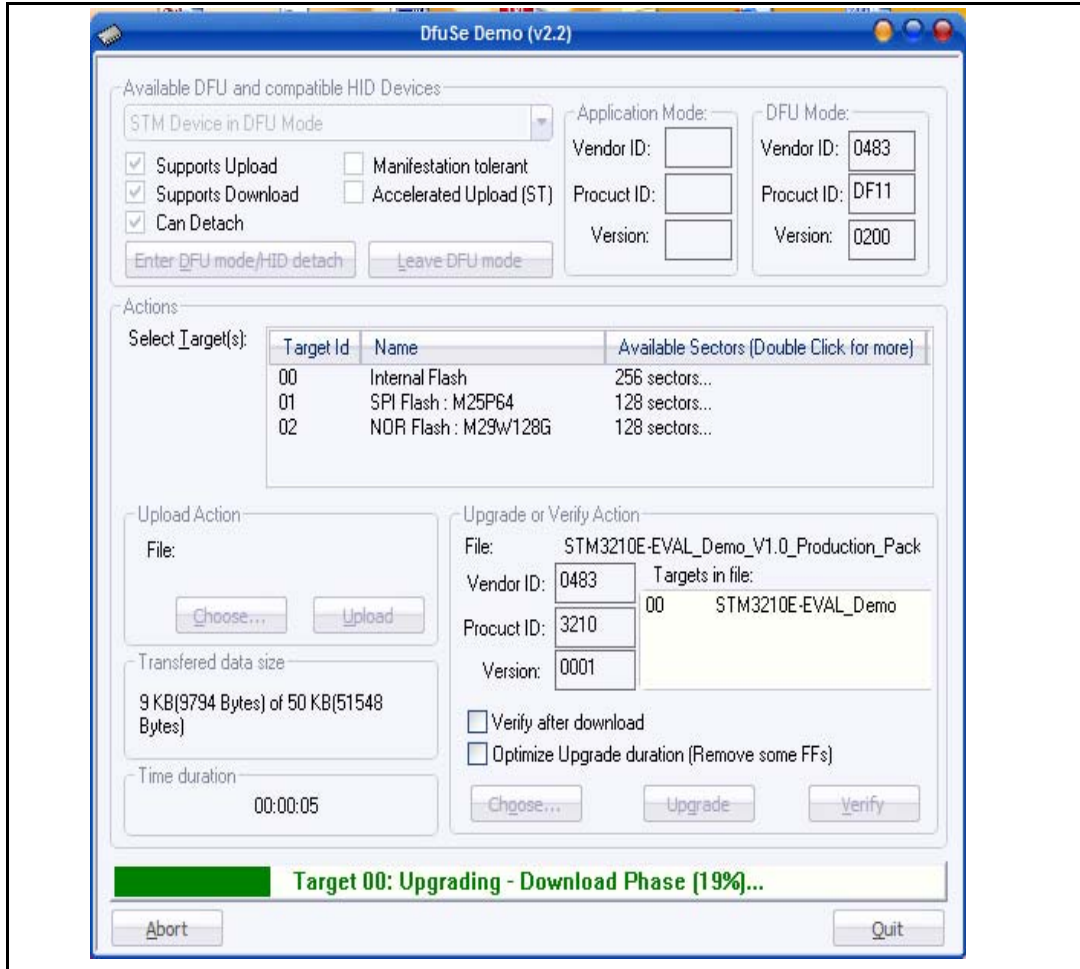

5. Once the internal Flash memory programming has completed, click on *Leave DFU Mode*, This causes the target to switch from DFU mode to Application mode, as shown in *Figure 83*. And the demonstration starts executing.

Figure 83. DFU mode left

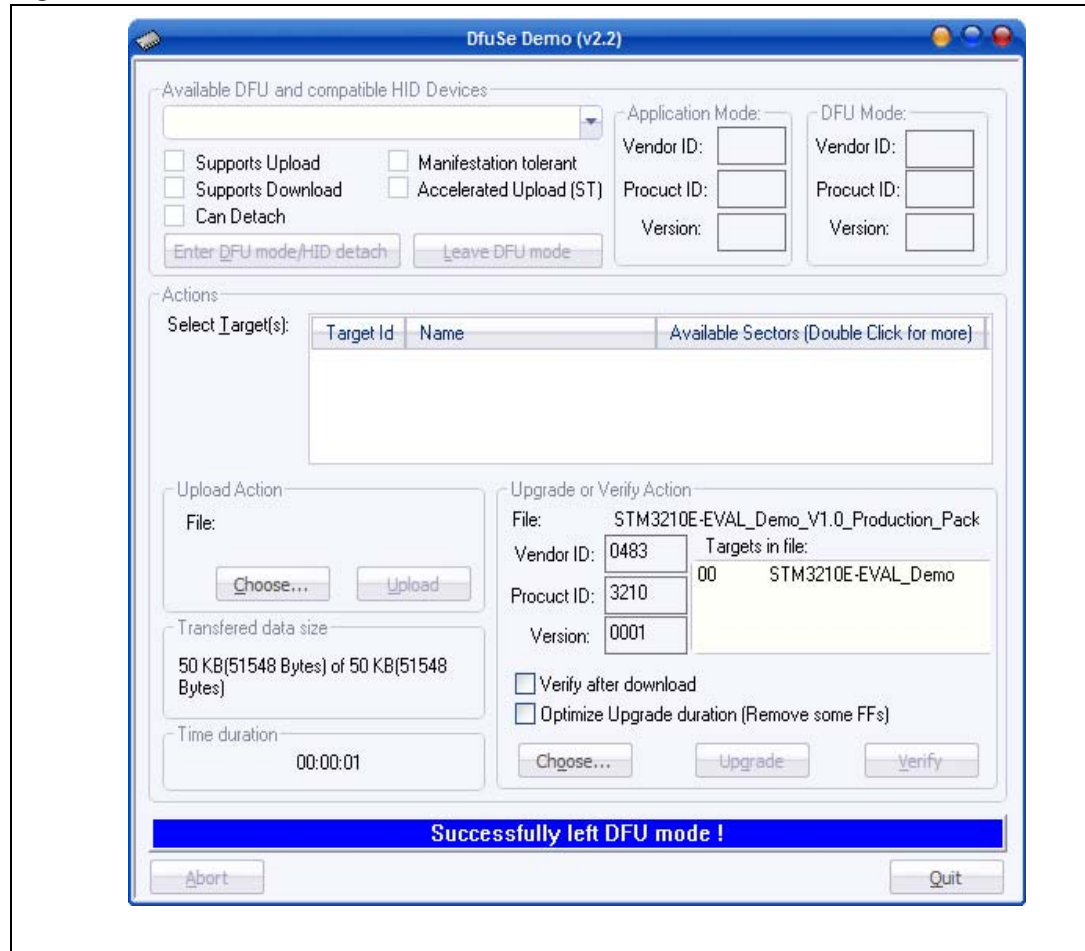

4 Revision history

Table 4. Document revision history

Date	Revision	Changes
22-May-2008	1	Initial release.
13-Jun-2008	2	<i>Caution: on page 36</i> reference to firmware license agreement removed. “STM3210E-EVAL information” figure removed.

Please Read Carefully:

Information in this document is provided solely in connection with ST products. STMicroelectronics NV and its subsidiaries ("ST") reserve the right to make changes, corrections, modifications or improvements, to this document, and the products and services described herein at any time, without notice.

All ST products are sold pursuant to ST's terms and conditions of sale.

Purchasers are solely responsible for the choice, selection and use of the ST products and services described herein, and ST assumes no liability whatsoever relating to the choice, selection or use of the ST products and services described herein.

No license, express or implied, by estoppel or otherwise, to any intellectual property rights is granted under this document. If any part of this document refers to any third party products or services it shall not be deemed a license grant by ST for the use of such third party products or services, or any intellectual property contained therein or considered as a warranty covering the use in any manner whatsoever of such third party products or services or any intellectual property contained therein.

UNLESS OTHERWISE SET FORTH IN ST'S TERMS AND CONDITIONS OF SALE ST DISCLAIMS ANY EXPRESS OR IMPLIED WARRANTY WITH RESPECT TO THE USE AND/OR SALE OF ST PRODUCTS INCLUDING WITHOUT LIMITATION IMPLIED WARRANTIES OF MERCHANTABILITY, FITNESS FOR A PARTICULAR PURPOSE (AND THEIR EQUIVALENTS UNDER THE LAWS OF ANY JURISDICTION), OR INFRINGEMENT OF ANY PATENT, COPYRIGHT OR OTHER INTELLECTUAL PROPERTY RIGHT.

UNLESS EXPRESSLY APPROVED IN WRITING BY AN AUTHORIZED ST REPRESENTATIVE, ST PRODUCTS ARE NOT RECOMMENDED, AUTHORIZED OR WARRANTED FOR USE IN MILITARY, AIR CRAFT, SPACE, LIFE SAVING, OR LIFE SUSTAINING APPLICATIONS, NOR IN PRODUCTS OR SYSTEMS WHERE FAILURE OR MALFUNCTION MAY RESULT IN PERSONAL INJURY, DEATH, OR SEVERE PROPERTY OR ENVIRONMENTAL DAMAGE. ST PRODUCTS WHICH ARE NOT SPECIFIED AS "AUTOMOTIVE GRADE" MAY ONLY BE USED IN AUTOMOTIVE APPLICATIONS AT USER'S OWN RISK.

Resale of ST products with provisions different from the statements and/or technical features set forth in this document shall immediately void any warranty granted by ST for the ST product or service described herein and shall not create or extend in any manner whatsoever, any liability of ST.

ST and the ST logo are trademarks or registered trademarks of ST in various countries.

Information in this document supersedes and replaces all information previously supplied.

The ST logo is a registered trademark of STMicroelectronics. All other names are the property of their respective owners.

© 2008 STMicroelectronics - All rights reserved

STMicroelectronics group of companies

Australia - Belgium - Brazil - Canada - China - Czech Republic - Finland - France - Germany - Hong Kong - India - Israel - Italy - Japan - Malaysia - Malta - Morocco - Singapore - Spain - Sweden - Switzerland - United Kingdom - United States of America

www.st.com

